

Leiterplatten Bohrplan Bestückungsseite  
PCB-Layout (component side)  
Toleranz  $\pm 0.05$  [ $\pm 0.002$ ]

Frontplattenausschnitt Rückseite  
panel cutout rearside

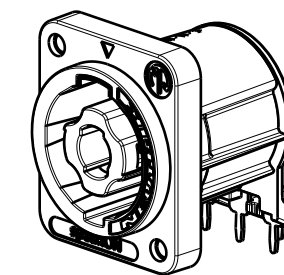
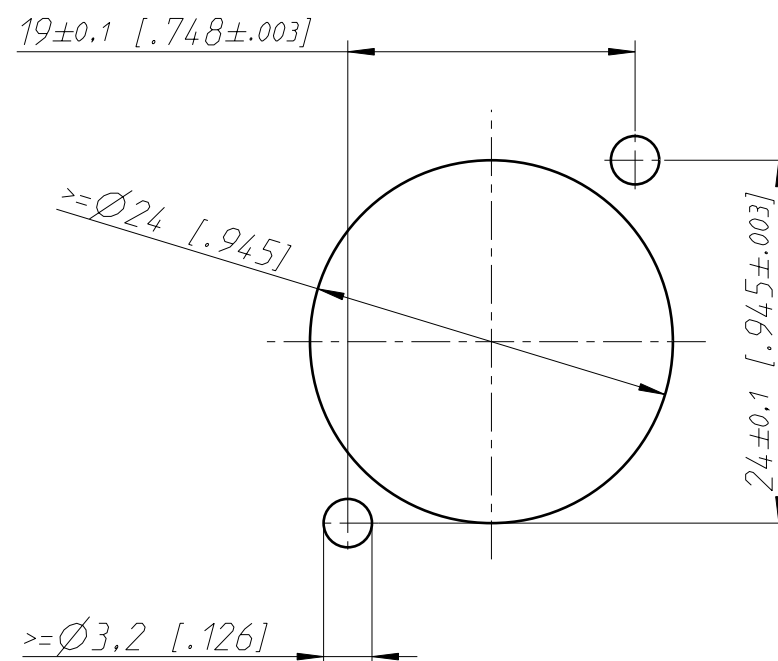
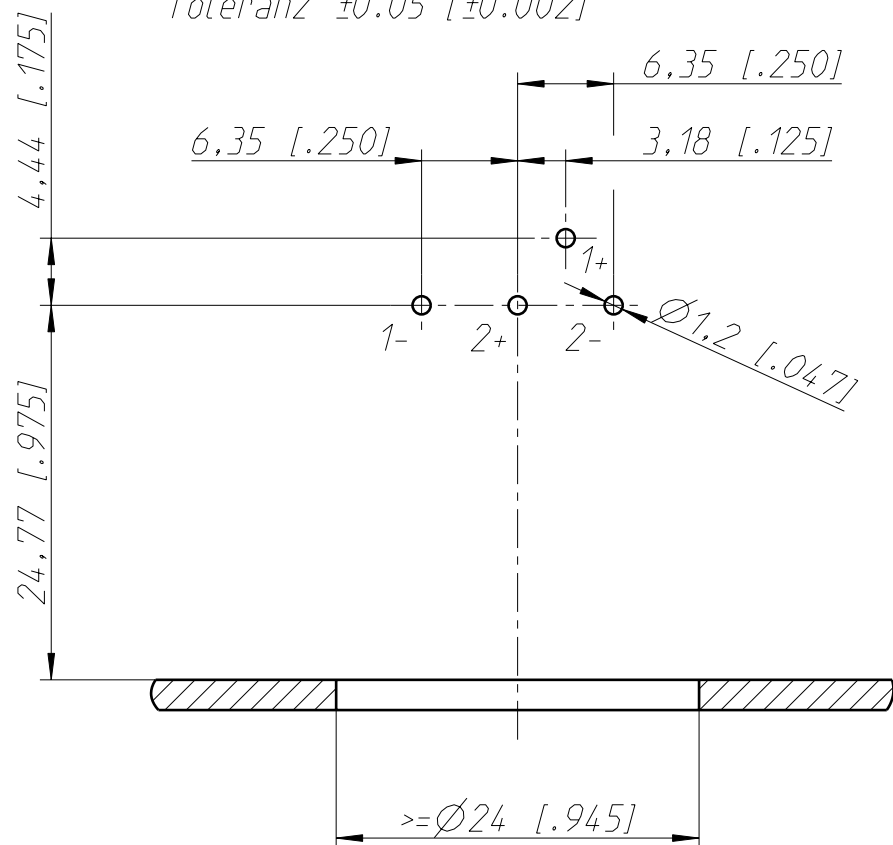

1:1

General tolerances ISO 2768-m	Scale	Date	Name
Refer to protection notice ISO 16016.	2:1 (A3)	05.11.19	Hofmann
Name		Drawn	Modified
NL4MDXX-H-3		-	-
		Change-No.	Sheet-No.
		-	1 / 1
		Index	-
Replacement for:		Drawing-No.	
NEUTRIK		ST-NL4MDXX-H-3	