



# ASSEMBLY INSTRUCTION

## speakON® STXX Series | NLT8MXX

Lockable 8 pole Loudspeaker Cable Connector with metal housing

### IMPORTANT SAFETY INSTRUCTION

CAUTION: NOT FOR INTERRUPTING CURRENT  
ATTENTION: NE PAS UTILISER POUR COUPER LE COURANT

Attention: speakON® is not to be used as an AC mains or power supply connector!

A

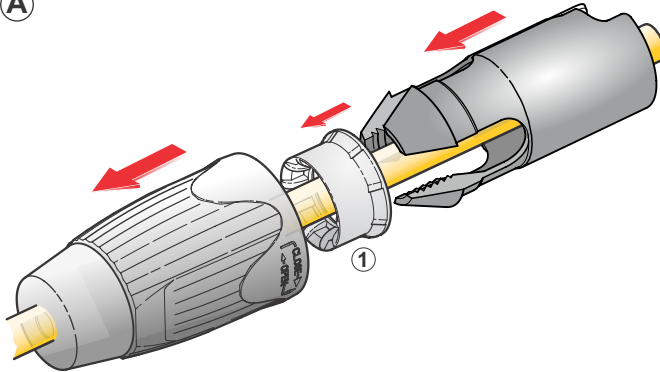

A Place bushing and chuck over the cable.

**If cable O.D.:**

**Less 16 mm please use reducing piece (1).**

B

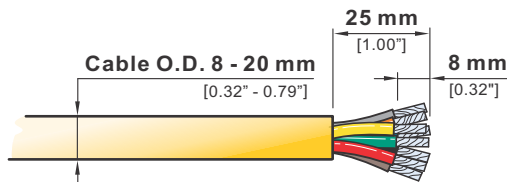

B Prepare cable as shown.

C Use 1/4" flat tabs or soldering to fix the wire ends to contacts of insert.

Wiring:

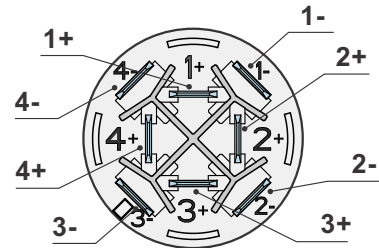

C

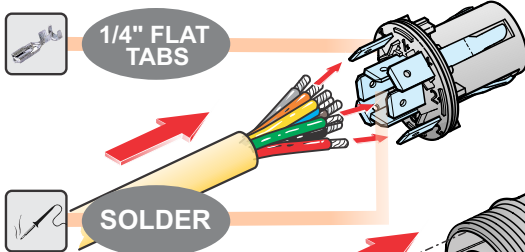

D Slide insert and chuck into housing.

**Important: Align the insert by positioning the Neutrik to the top of the housing.**

D

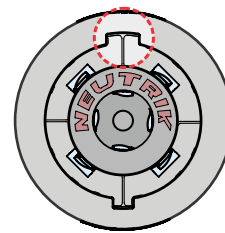
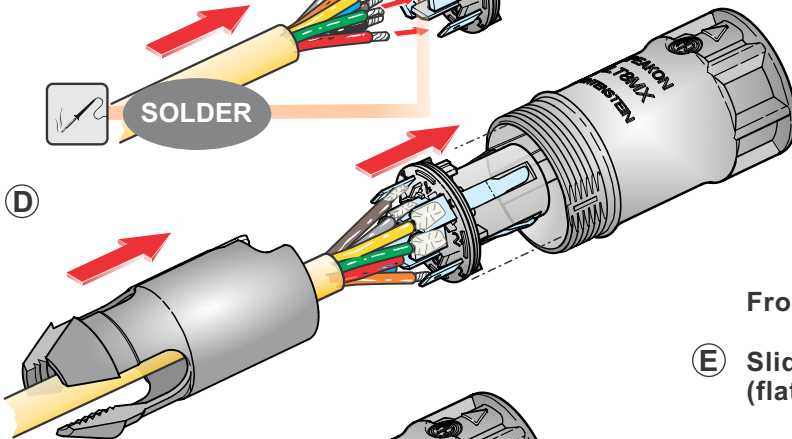

Front view:

E

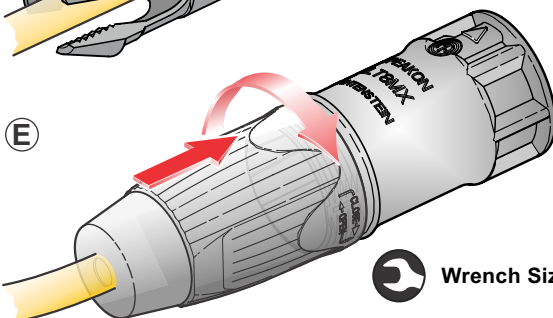

E Slide the bushing up the cable and tighten it (flat wrench SW 27 mm).

Wrench Size = 27



Find more details of speakCON on [www.neutrik.com](http://www.neutrik.com).

Neutrik AG LI T: +423 / 237 24 24 F: +423 / 232 53 93  
Neutrik USA Inc. USA T: +1 704 / 972 3050 F: +1 704 / 438 9202  
Neutrik (UK) Ltd. UK T: +44 1983 / 811 441 F: +44 1983 / 811 439  
Neutrik Vertriebs GmbH DE/NL/AT/DK T: +49 8131 / 280 890 F: +49 8131 / 280 830

Neutrik France FR T: +33 1 / 4131 6750 F: +33 1 / 4131 0511  
Neutrik Tokyo Ltd. JP T: +81 3 / 3663 4733 F: +81 3 / 3663 4796  
Neutrik Hong Kong Ltd. HK T: +852 / 2687 6055 F: +852 / 2687 6052

Draft. Nr.: BDA 616 V2 | Update: 2021-07-06 | Data subject to change without prior notice. © 2021 NEUTRIK®, NEUTRIK® are registered trademark of Neutrik AG. ALL RIGHTS RESERVED.

[www.neutrik.com](http://www.neutrik.com)

**NEUTRIK®**