



**Technical Paper |**  
**opticalCON® DUO**

# Content

1	Optical Attenuation.....	3
2	Vibration.....	5
3	Cable Retention .....	10
4	Locking Mechanism .....	11
5	Impact.....	12
6	Mating Durability .....	14
7	Advanced Durability Test.....	17
8	Change of Temperature .....	18
9	Flexing .....	19
10	Dust.....	21
11	Sealing Gasket .....	23
12	Cable Drum .....	24
13	Contact Resistance.....	25
14	Dielectric Strength.....	26
15	Insulation Resistance.....	27
16	Current Capacity .....	28

**Technical Paper – opticalCON DUO**

Title: NTPO4

© NEUTRIK® AG. All rights reserved.

Subject:

Mechanical and optical tests applied to the opticalCON® transmission system for Pro Audio / Video industry purposes with main focus on changes in attenuation.

Optical performance is being examined with regard to attenuation and its variation vs. environmental and mechanical conditions.

This documentation describes the results of the test series conducted at Neutrik AG and University of Applied Sciences of Technology Buchs NTB.

The tests were carried out in accordance with the IEC-Standard main groups IEC 60794 and IEC 61300 as well as to Neutrik internal specifications.

NEUTRIK AG is not to be held liable for statements and declarations given in this technical paper.

NEUTRIK AG explicitly exonerates itself from all liability for mistakes in this white paper.



## 1 Optical Attenuation

### Object:

Examination of the receptacle NO2-4FDW-A in combination with the opticalCON® cable connector to determine the attenuation in a fiber optic system.

For the test of the cable connector a completely assembled opticalCON cable was used. See fig. 1.

### Test Set-Up:

Test specimens:

Single-mode:	NKO2SA-0-2 (2 m length)
Multimode:	NKO2M-0-1 (1 m length)

Test procedure according to IEC 61300-3-4 figure 4 with mode filter described in table 3 for multimode, for single-mode no mode filter was used.

Test equipment:	EXFO FLS-600	light source
	EXFO FPM-600	power meter
Launching cables:	0.9 mm precision fibres	
Reference complex:	precision adapter FLC-FLC	
Measuring wave lengths:	1.310 nm	single-mode
	850 nm	Multimode
Comment	Short cable lengths do not affect attenuation remarkably and are therefore not considered.	

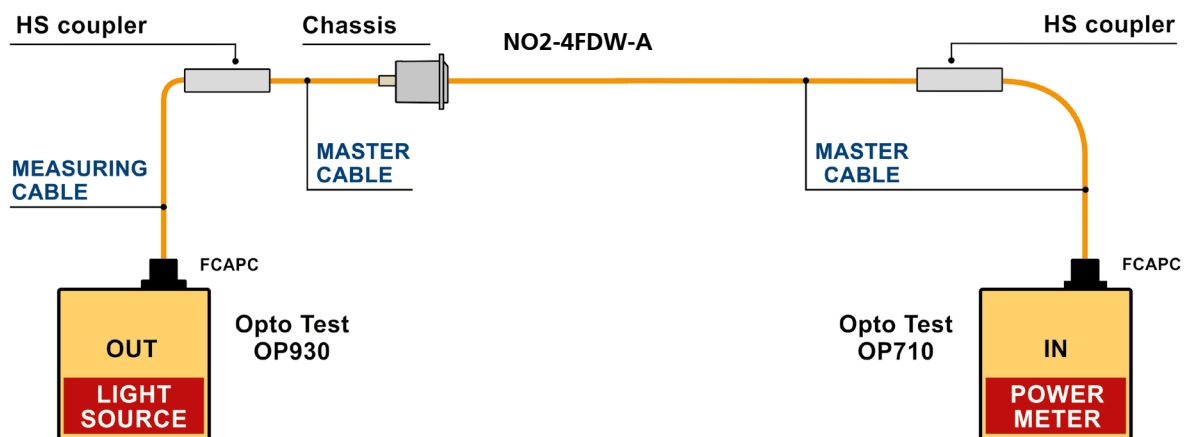

figure 1.a: Simplified measuring arrangement

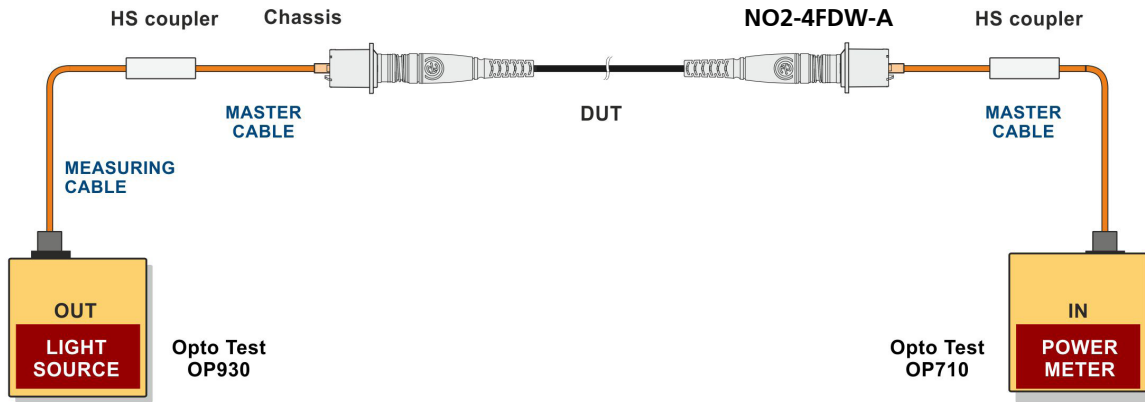

figure 1.b: Simplified measuring arrangement

**Limit Values (per mating pair):**

Single-mode:	0.25 dB
Multimode:	0.45 dB

**Results:**

Basis of test series: 50 sets of cable assemblies

Single-mode:	0.10 – 0.44 dB
Multimode:	0.35 – 0.75 dB

## 2 Vibration

### Object:

Examination of the two components, receptacle NO2-4FDW-A and the opticalCON cable connector. The intention of the test was to determine their attenuation in a fiber optic system before, during and after the vibration test.

In addition the test presents the change in contact resistance of the electrical contacts as well as the function of the mechanical locking system and the wear.

The test was carried out by an independent laboratory: NTB, "Interstaatliche Hochschule für Technik Buchs" division "Labor Mess- und Simulationstechnik" located in Buchs / Switzerland.

### Test Set-Up:

For the vibration test two receptacles NO2-4FDW-A per axis were mounted. The front side was mated with a NKO2M-H1-0-1 opticalCON cable. The rear end was connected with the test instrument via precision measuring cables (see fig. 3 a/b).

The applied test set-up complies with IEC 61300-2-1 table 1.

Shaker:	TIRAVIB Model 5200, controlled by an external power amplifier and a PC with software VibeLab-Pro (fig. 3 a/b).	
Test instruments:	EXFO FLS-600	light source
	EXFO FPM-600	power meter
Launching cables:	0.9 mm precision fibres, assembled by H&S	
Measuring wave lengths:	1.310 nm	single-mode
	850 nm	multimode
DUT cable length:	2 m	single-mode
	1 m	multimode
Comment:	Short cable lengths do not affect attenuation remarkably and to be therefore not considered.	

### Vibration Severity:

Frequency range:	10 – 55 Hz
Amplitude displacement:	1.52 mm (3.04 mm p-p)
Acceleration:	up to 20 g (200 m/s <sup>2</sup> )
Sweep rate:	2 min/cycle
Number of sweeps:	15
Axis:	X, Y, Z

After 15 cycles the receptacles were changed to the next axis without disconnecting the pugs to avoid any mismatching.

### Results:

Attenuation before, during and after vibration test:

#### Changes in attenuation:

Single-mode:	- 0.08 dB to - 0.03 dB
Multimode:	- 0.03 dB to + 0.13 dB

The reason for the attenuation improvement compared to the initial values may result from new positioned ferrules as a result of vibration.

Measurement during vibrations showed no variation in attenuation.

### Electrical Contact Resistance

The contact resistance has changed from 4.6 mΩ average to 4.7 mΩ per contact.

### Mechanical

The locking mechanism withstands this extreme vibration without any problems, i. e. no separation or functional deterioration occurred.



figure 2.a: Vibration equipment and test cable arrangement



figure 2.b: : Vibration equipment and test cable arrangement

**Objekt:**

Examination of the sealing dust cover SCNO-FDW-A to analyse the performance and mechanical durability during defined vibration cycles.  
 The applied test set-up complies with IEC 61300-2-1:2004.

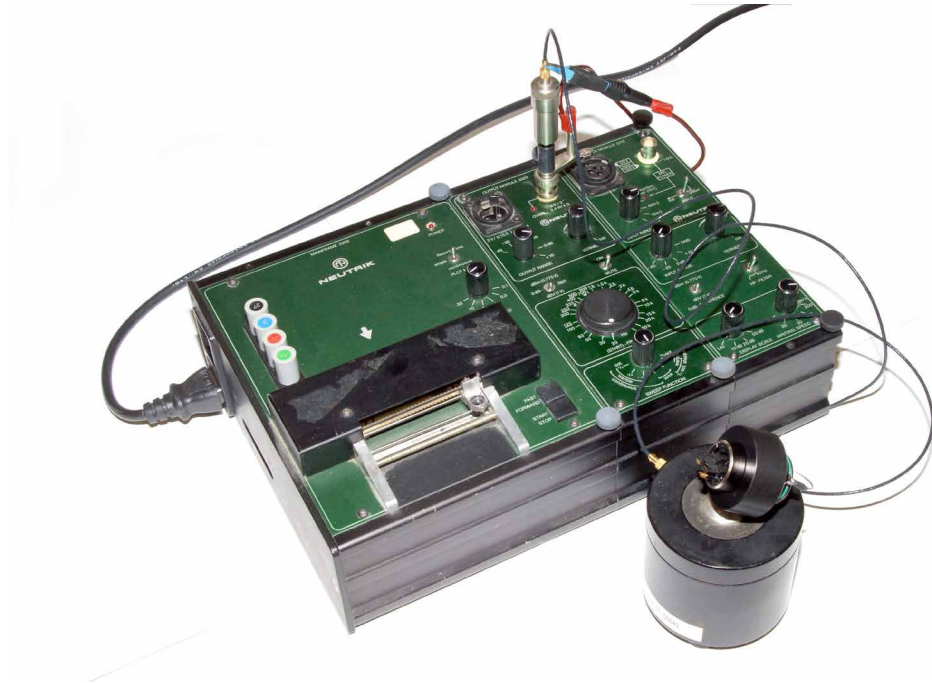

figure 1.d : Test Setup

**Vibration Severity:**

Shaker:	Brüel&Kjaer Mini Shaker Type 4810 and Neutrik Frequency Generator
Frequency range:	10 Hz – 18 kHz
Amplitude displacement:	1.75 mm (3.5 mm peak-peak) @ 40 Hz
Test components:	NO2-4FDW-A (opticalCON DUO chassis) SCNO-FDW-A (sealing dust cover)
Axis:	X, Y, Z



**Test Results:**

No reasonable mechanical degradation of the sealing dust cover during and after vibration test.



figure 2.e



figure 2.f

### 3 Cable Retention

**Object:**

Test of the cable retention efficiency. The opticalCON cables NKO\* were exposed to tractive forces until the cable started to move.

**Test Set-Up:**

The applied test procedure is referred to IEC 61300-2-4.

Tension-Tester:	Versa Test Mecmesin 0 – 1.000 N
Measuring Instruments:	AFG-R 1000N Mecmesin
Assembled cable types:	NKO2M-A-0-1 (multimode 2 fibers)
	NKO2M-H1-0-1 (multimode 2 fibers and 4 copper wires)
	NKO2SA-A-0-1 (single-mode 2 fibers)
	NKO2SA-S1-0-1 (SMPTE single-mode 2 fibers and 4 copper wires)

**Results:**

NKO2M-A-0-1	> 500 N
NKO2M-H1-0-1	> 500 N
NKO2SA-A-0-1	> 500 N
NKO2SA-S1-0-1	> 350 N



figure 3.a: Equipment for examination of cable retention

---

## 4 Locking Mechanism

---

**Object:**

Tensile strength measurement of the locking mechanism.

**Test Set-Up:**

Same test set-up as used in clause 3. Cable Retention. Instead of the cable a mechanical adapter was used to fix the plug.

**Results:**

Tensile strength	> 1.000 N
------------------	-----------

At a force of 1.000 N the test was stopped without any damages of the locking device.

## 5 Impact

### Object:

The impact test is performed to show possible deformations or plug malfunction of the internal mechanism due to heavy mechanical exposure.

### Test Set-Up:

The applied test procedure is referred to the IEC 61300-2-12 Method A pendulum drop (fig. 5).

Test item:	opticalCON cable connector
First part of test:	front side of connector protected by a protection cap of EPDM (protection cap is supplied with each cable drum)
Second part of test:	no connector protection

### Parameters of Test:

Distance from centre of rotation:	2.25 m
Number of drops:	5
Height of falling:	1.0 – 1.9 m
Ground:	steel plate, thickness 25 mm
Plug fixation:	small wire

### Results:

Tests 1 – 3:	No visible abrasions, no functional problems
Test 4:	Minimal abrasions at the edge of the plug, but no functional problems



figure 5.a: Test set-up “Impact”

TEST #	with cap	drop heigh [m]	drops	comment	result
1	yes	1.0	5	-	no visible abrasion full function
2	yes	1.9	5	-	no visible abrasion full function
3	yes	1.0	5	extremely manual acceleration	no visible abrasion full function
4	no	1.5	5	valuation after each drop	minimum abrasion full function

Table 5.a: Impact test IEC 61300-2-12 method A

## 6 Mating Durability

### Object:

The mating durability test was carried out to show variations in attenuation (optical) and of electrical contact resistance after lifetime.

### Test parameter:

NKO2S-A-0-1 (single mode 2 fibres)

NKO2S-S1-0-1 (SMPTE; single-mode 2 fibres and 4 copper wires)

### Test Set-Up:

Test procedure according to IEC 61300-2-2 in combination with IEC 61300-3-4 figure 4 with mode filter as defined in table 3 for multimode, no mode filter for single-mode. Contact resistance measurement according to IEC 60512-2. The test was realized with the equipment shown in fig. 6.

Mating cycles:	500 (durability test) 5.000 (lifetime test)	
Launching:	EXFO FLS-600 EXFO FPM-600	light source power meter
Microscope:	enlarged x 200	
Measuring cables:	0.9 mm precision fibers, assembled by H&S	
Measuring wave lengths:	1.310 nm	single-mode
DUT cable length:	1 m	

### Results:

#### 500 cycles (durability test):

The microscopic assay didn't show any reasonable degradation. The attenuation values still fulfill Neutrik's internal requirements of < 0,45 dB/connection.

Single-mode: 0.30 dB degradation without cleaning, 0.25 dB degradation after cleaning.

The test results of the electrical contacts are handled in chapter 11.

#### 5.000 cycles (lifetime test)

The visual inspection didn't show any reasonable degradation from the condition of the fiber (scratches, soil remains, outbreaks, etc.). The functionality from the shutters as well as the locking mechanism is warranted. During measuring procedure there are no significant variations.

MEASURING	BEFOREE LIFETIME TEST [dB]	AFTER LIFETIME TEST [dB]
Return Loss	58.3	56.8
Insertion Loss	0.16	0.25

### 500 cycles - Durability test

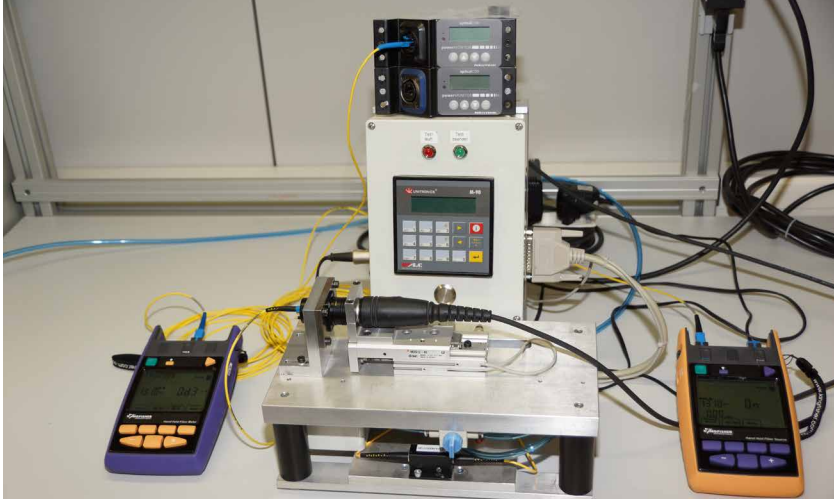

figure 6.a: measuring setup for durability and lifetime test



figure 6.b: fixture for 500 and 5.000 mating cycles

### Fiber condition

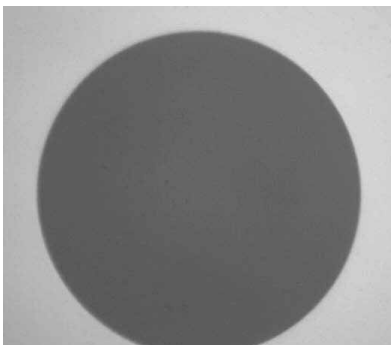

figure 6.c: Ch1 / sm: - no visual degradation (scratches, soil, etc.)

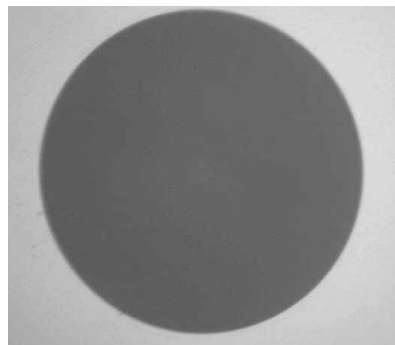

figure 6.d: Ch2 / sm: no visual degradation (scratches, soil, etc.)

5.000 cycles - Lifetime test

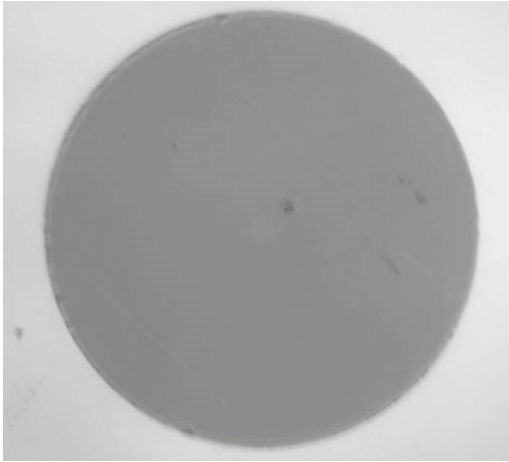

figure 6.e

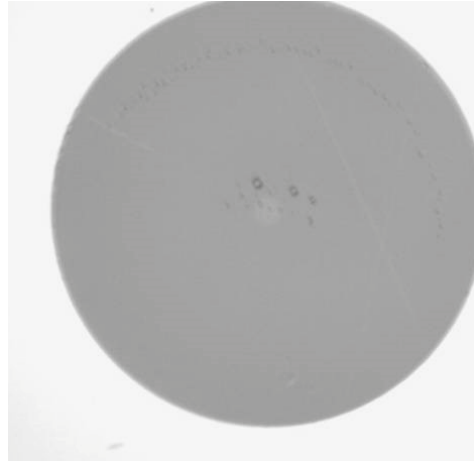

figure 6.f

CH1 and CH2 didn't indicate a significant degradation. Partly some soil remains around the core which has no reasonable influence of the measurement parameters (see table on the top).



No mechanical degradations on the opticalCON DUO cable connector.

figure 6.g



Proper functionality of the shutter and locking mechanism

figure 6.h



## 7 Advanced Durability Test

### Object:

The advanced durability test is performed to show possible deformations or plug malfunction of the internal mechanism due to heavy mechanical exposure after conditioning cabinet.

### Test parameter:

opticalCON chassis: NO2-4FDW-A

### Test Set-Up:

The opticalCON chassis NO2-4FDW-A stays 24 hours in the conditioning cabinet with defined temperature cycles. After the temperature test procedure the opticalCON chassis starts a 5.000 mating lifetime test.

Mating cycles:	5.000
Fixture:	internal mating cycle test fixture (see section 6)
Cable	NKO2S-A-0-5
Conditioning cabinet:	WEISS WK11-180/40
Test temperatures:	-20 °C / +75 °C
Humidity:	10 %
Duration:	24 h

### Results:

After 5.000 mating cycles and temperature test the opticalCON chassis NO2-4FDW-A (Fig. 7.a) didn't show any significant deformations or mechanical malfunction. The greased O-ring didn't indicate any cracks or rough areas (Fig. 7.b).



figure 7.a: Test chassis NO2-4FDW-A



figure 7.b: O-ring after 5000 mating cycles

## 8 Change of Temperature

### Object:

Variations in attenuation due to temperature changes.

The test was arranged with a single-mode cable drum which is more critical than multimode.

### Test Set-Up:

Test procedure according to IEC 61300-2-22 in combination with IEC 61300-3-4 (Fig 8.a).

The test was realized in a temperature testing chamber type WEISS WK11-180/40.

Test cycles:	16 (96 h)	
Profile of temperature:	-40 °C to +75 °C (fig. 6)	
Test instruments:	EXFO FLS-600	light source
	EXFO FPM-600	power meter
Launching cables:	0.9 mm precision fibers, constantly connected with the DUT (device under test) through a hole in the test chamber.	
Measuring wave lengths:	1.310 nm	single-mode
Cable length:	300 m	
Test specimen:	NKO2SA-A-3-300	

### Results:

Maximum increase in attenuation 0.2 dB over the whole temperature range.

## 9 Flexing

### Object:

Variations of attenuation and mechanical damage of fiber optic cable due to a defined flexing procedure.

Assembled cable types:

NKO2M-A-0-1 (Multimode 2 fibres)

NKO2SA-A-0-1 (single-mode 2 fibres)

NKO2SA-S1-0-1 (SMPTE; single-mode 2 fibres and 4 copper wires)

### Test Set-Up:

Measurement of attenuation before, during and after flexing cycles.

Test procedure according to IEC 61300-2-44 in combination with IEC 61300-3-4 Fig. 9.a with mode filter as defined in table 3 for multimode, no mode filter for single-mode.

Test equipment:	fig. 7 and 8	
Test cycles:	1.000 / 5.000	
Mass of weight:	10 N or 20 N depending on cable type	
Flexing angle:	± 90°	
Flexing speed:	ca. 12 cycles/min	
Test Instruments:	EXFO FLS-600	light source
	EXFO FPM-600	power meter
Launching cables:	0.9 mm precision fibers, assembled by H&S	
Measuring wave lengths:	1.310 nm	single-mode
	850 nm	multimode
DUT cable length:	1 m	single-mode
	1 m	multimode

### Results:

a) Change in attenuation:

Single-mode	0.05 dB to 0.20 dB
Multimode	0.00 dB to 0.03 dB

b) Mechanical cable damage:

1.000 cycles:	no damage
5.000 cycles:	no significant damage, single strands (AWG 16) of SMPTE cable partly broken

NO2-4FDW-A  
NKO2\*.\*

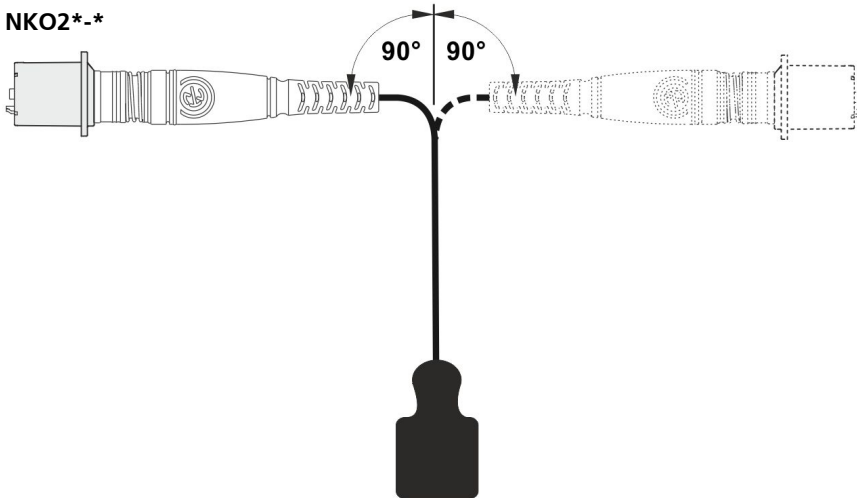

figure 9.a: Principle of Test according to IEC 61300-2-44 (IEC 61300-3-4)



figure 9.b: Test Equipment and Fixture for flexing test

## 10 Dust

### Object:

Variations of attenuation due to massive dust penetration. The test was carried out with single-mode cables where soiling of the connecting surface effects much more attenuation than at multimode cables.

The test was carried out by an independent laboratory: Electrosuisse, test laboratory PQ/PIK in 8320 Fehraltorf, Switzerland.

### Test Set-Up:

The opticalCON connector was exposed to dust from both sides in wired condition for 60 minutes. The built-in sealing shutters protected the optical conductor at the front side; the plugged-in LC-Duplex connectors shielded the rear side.

Test procedure according to IEC 61300-2-27 in combination with IEC 61753-1-1 Tab. A5 Test No.16 and IEC 61300-3-4 figure 4.

Test specimen:	NO2-4FDW-A – Receptacle	
Particle size:	d < 150 µm	
Dust type:	talcum powder	
Temperature	19 °C	
Relative humidity:	54 %	
Duration of penetration:	1 h	
Test Instruments:	EXFO FLS-600	light source
	EXFO FPM-600	power meter
Launching cables:	0.9 mm precision fibers	
Measuring wave lengths:	1.310 nm	single-mode
DUT cable length:	2 m	single-mode

### Results:

MEASURING	INITIAL	Attenuation [dB]	AFTER CONTAMINATION
NO2-4FDW-A	A	0.31	0.34
	B	0.36	0.38

Table 10.a: Dust test

Channel A was defined as for the front side of the receptacle

The corresponding power level was calibrated at 4.91 dBm @ 1.310nm (= 0.00dB)

Maximum increase in attenuation: 0.03 dB

The IP rating can be defined with IP 5x.



figure 10.b: Dust sediment on the rear side of the receptacle after 60 min.



figure 10.c: Dust sediment on the front side of the receptacle after 60 min.

## 11 Sealing Gasket

### Object:

Durability test of the sealing cover surface. Long-term load of the closed sealing cover by a constant laser beam.

The intention is to find out if the silicon layer alters or a deposition is formed on the fiber surface of the connector.

### Test Set-Up:

An interconnection was inserted into a chassis connector type NO2-4FDW-A from the rear. The fiber surface of the interconnection had direct contact to the cover surface. The second end of the interconnection was connected to a light source.

Light source:	EXFO FLS-600	
Power meter:	EXFO FPM-600	
Test parameter:	Wavelength:	1.310 nm
Output power:	4.6 dBm (referenced 0 dB)	
Duration:	12 h	

### Results:

No difference between referencing and measuring after the duration of test:  $\pm 0$  dB.

The surfaces of the fiber and the gasket as well showed no mechanical variation in the area of the fiber contact (checked by microscope).

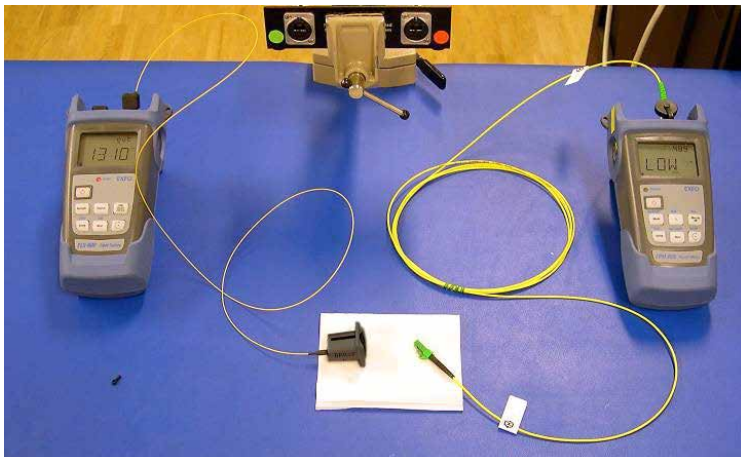

figure 11.a: Test Set-Up

---

## 12 Cable Drum

---

### Object:

Variations of attenuation due to winding quality on cable drums.

First part of the test:	attenuation measurement of perfectly wound drum
Second part of test:	attenuation measurement of unwinded cable
Third part of the test:	spooling of the cable drum in a typical on stage manner, i. e. with a lot of crossed cable windings; attenuation measurement

### Test Set-Up:

Test procedure according to chapter 1 Attenuation.

### Parameters:

Drum assembly:	NKO2SA-A-3-100
Cable length:	1.000 m
Wave length:	1.310 nm

### Results:

First test (spooled cable drum):

channel A:	0.34 dB
channel B:	0.37 dB

Second test (unwinded cable drum): change in attenuation – 0.04 dB to - 0.07 dB

Third test (spooled cable drum): increase of initial attenuation + 0.01 dB to + 0.08 dB



### 13 Contact Resistance

**Object:**

Initial value and variation of contact resistance.

opticalCON cable connector mated with the receptacle NO2-4FDW-A before and after 1.000 mating cycles.

**Test Set-Up:**

Test procedure according to IEC 60512-2 test 2a

Measuring Instrument: HIOKI – 3540 Millivoltmeter

**Results:**

CONTACT RESISTANCE [mΩ]		
	measured average value	conditional value
initial	4.6	6.0
after 1.000 cycles	5.7	7.0

Table 13.a: contact resistance

---

## 14 Dielectric Strength

---

### Object:

Same test set-up as used in clause 11 Contact Resistance. It was checked in completely mated, half mated and unmated condition. Each combination of contact to contact and contact to shell was judged.

### Test Set-Up:

Test procedure according to IEC 60512-2 test 4a

Measuring Instrument:	GOR-1 Dielectrometer
Test Parameter:	0 – 6 kV
The conditional value of dielectric strength was defined with > 1.5 kV.	

### Results:

Minimum dielectric strength:	2.0 kV
------------------------------	--------

---

## 15 Insulation Resistance

---

### Object:

Same test set-up as used in clause 11 Contact Resistance.

### Test Set-Up:

Test procedure according to IEC 60512-2 Test 3a

Measuring Instrument:	METRISO C	
	maximum measurable isolation resistance	100 GΩ
Test Parameter:	test voltage 500 V DC	
The insulation resistance was defined with > 10 GΩ.		

### Results:

Minimum insulation resistance:	64.7 GΩ
--------------------------------	---------

## 16 Current Capacity

### Object:

Temperature rise of contacts as a result of electrical current.

### Test Set-Up:

Test procedure according to IEC 60512-5-1 test 5a

Current source:	VAREG, 3 V 0-50 A rms
Measuring Instrument:	TESTO 935 Thermometer, 2 channels
Temperature:	-50 – +350 °C

The maximum temperature rise was defined generally with < 40 K.

The measurements were realized for the following wires and currents:

1	contacts 1-4	wired with 0.22 mm <sup>2</sup>	6 Amps through all contacts
2	contacts 1+4	wired with 1.5 mm <sup>2</sup>	10 Amps through both contacts in case of SMPTE application
3	contacts 1+4	wired with 1.5 mm <sup>2</sup>	10 Amps through both contacts
4	contacts 2+3	wired with 0.22 mm <sup>2</sup>	1 Amp through both contacts in case of SMPTE application

### Results:

Ad 1:	26.7 K
Ad 2:	23.1 K
Ad 3:	28.6 K

A rated current of 6 A (10 A for the SMPTE cable) can be defined.



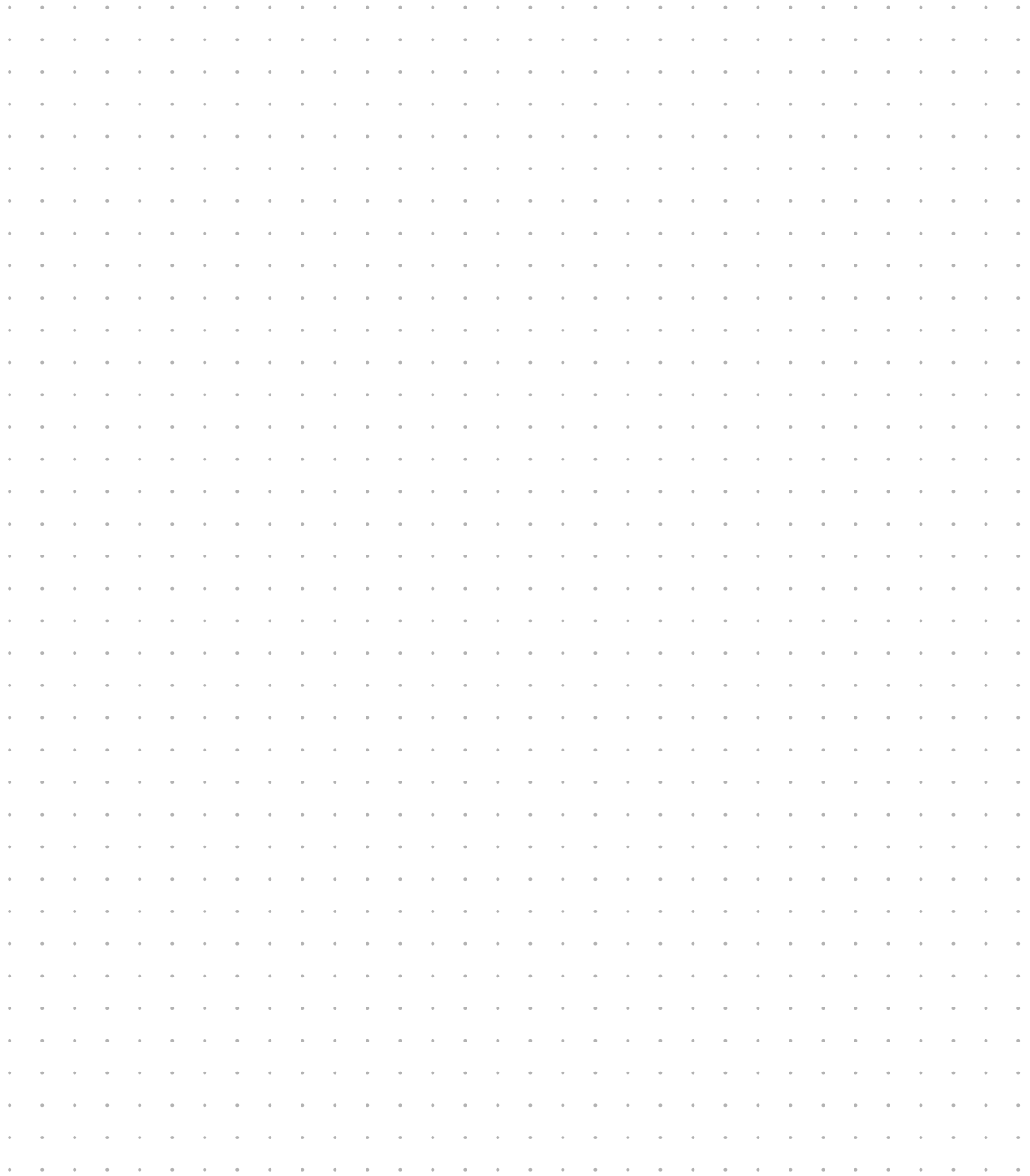



# opticalCON DUO TECHNICAL PAPER

## Liechtenstein (Headquarters)

NEUTRIK AG, Im alten Riet 143, 9494 Schaan  
T +423 237 24 24, F +423 232 53 93, neutrik@neutrik.com

## Germany / Netherlands / Denmark / Austria

Neutrik Vertriebs GmbH, Felix-Wankel-Strasse 1, 85221 Dachau, Germany  
T +49 8131 28 08 90, info@neutrik.de

## Great Britain

Neutrik (UK) Ltd., Westridge Business Park, Cothey Way  
Ryde, Isle of Wight PO33 1 QT  
T +44 1983 811 441, sales@neutrik.co.uk

## France

Neutrik France SARL, Rue du Parchamp 13, 92100 Boulogne-Billancourt  
T +33 1 41 31 67 50, info@neutrik.fr

## USA

Neutrik USA Inc., 4115 Taggart Creek Road, Charlotte, North Carolina, 28208  
T +1 704 972 30 50, info@neutrikusa.com

## Japan

Neutrik Limited, Yusen-Higashinohonbashi-Ekimaie Bldg., 3-7-19  
Higashinohonbashi, Chuo-ku, Tokyo 103  
T +81 3 3663 47 33, mail@neutrik.co.jp

## Hong Kong

Neutrik Hong Kong LTD., Suite 18, 7th Floor Shatin Galleria  
Fotan, Shatin  
T +852 2687 6055, neutrik@neutrik.com.hk

## China

Ningbo Neutrik Trading Co., Ltd., Shiqi Street, Yinxian Road West  
Fengjia Villiage, Yinzhou Area, Ningbo, Zhejiang, 315153  
T +86 574 88250488 800, neutrik@neutrik.com.cn

## India

Neutrik India Pvt. Ltd., Level 3, Neo Vikram, New Link Road,  
Above Audi Show Room, Andheri West, Mumbai, 400058  
T +91 982 05 43 424, anklesaria@neutrik.com

## Associated companies

### Contrik AG

Steinackerstrasse 35, 8902 Urdorf, Switzerland  
T +41 44 736 50 10, contrik@contrik.ch

### H. Adam GmbH

Felix-Wankel-Straße 1, 85221 Dachau, Germany  
T +49 08131 28 08-0, info@adam-gmbh.de

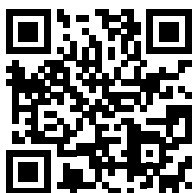

[www.neutrik.com](http://www.neutrik.com)