

@Lumen8



200W 3200K BLINDER

Code: ELUM062



WARNING

**FOR YOUR OWN SAFETY, PLEASE READ THIS USER MANUAL CAREFULLY
BEFORE YOUR INITIAL START-UP!**



CAUTION!

**Keep this equipment away from rain,
moisture and liquids.**



SAFETY INSTRUCTIONS

Every person involved with the installation, operation & maintenance of this equipment should:

- Be competent
- Follow the instructions of this manual



**CAUTION! TAKE CARE USING THIS EQUIPMENT!
HIGH VOLTAGE-RISK OF ELECTRIC SHOCK!!**



Before your initial start-up, please make sure that there is no damage caused during transportation. Should there be any, consult your dealer and do not use the equipment.

To maintain the equipment in good working condition and to ensure safe operation, it is necessary for the user to follow the safety instructions and warning notes written in this manual.

Please note that damages caused by user modifications to this equipment are not subject to warranty.

IMPORTANT:

The manufacturer will not accept liability for any resulting damages caused by the non-observance of this manual or any unauthorised modification to the equipment.

- Never let the power-cable come into contact with other cables. Handle the power-cable and all mains voltage connections with particular caution!
- Never remove warning or informative labels from the equipment.
- Do not open the equipment and do not modify the equipment.
- Do not connect this equipment to a dimmer-pack.
- Do not switch the equipment on and off in short intervals, as this will reduce the system's life.
- Only use the equipment indoors.
- Do not expose to flammable sources, liquids or gases.
- Always disconnect the power from the mains when equipment is not in use or before cleaning! Only handle the power-cable by the plug. Never pull out the plug by pulling the power-cable.
- Make sure that the available voltage is between 100v/240v.
- Make sure that the power-cable is never crimped or damaged. Check the equipment and the power-cable periodically.
- If the equipment is dropped or damaged, disconnect the mains power supply immediately. Have a qualified engineer inspect the equipment before operating again.
- If the equipment has been exposed to drastic temperature fluctuation (e.g. after transportation), do not switch it on immediately. The arising condensation might damage the equipment. Leave the equipment switched off until it has reached room temperature.
- If your product fails to function correctly, discontinue use immediately. Pack the unit securely (preferably in the original packing material), and return it to your Prolight dealer for service.
- Only use fuses of same type and rating.
- Repairs, servicing and power connection must only be carried out by a qualified technician. **THIS UNIT CONTAINS NO USER SERVICEABLE PARTS.**
- **WARRANTY;** One year from date of purchase.

OPERATING DETERMINATIONS

If this equipment is operated in any other way, than those described in this manual, the product may suffer damage and the warranty becomes void.

Incorrect operation may lead to danger e.g.: short-circuit, burns, electric shocks, lamp failure etc.

Do not endanger your own safety and the safety of others!

Incorrect installation or use can cause serious damage to people and property.

Overview:

You should find inside the Elumen8 carton the following items:

1, 200W 3200K Blinder

2, Instruction manual,

3, Power Cable

Technical Specifications:

- DMX channels: 1/2 or 4 selectable
- 2 x 100W LEDs
- Dimming, master/slave and DMX modes
- Individually addressable LEDs
- 400Hz refresh rate
- Powercon in/out sockets
- 3-Pin XLR in/out sockets
- 5-pin XLR in/out sockets
- 4 push button menu with LCD display
- 0-100% dimming and variable strobe
- Beam angle: 60 degrees
- Fan cooled
- Power consumption: 270W
- Power supply: 110-240V~50Hz-60Hz
- Dimensions: 425 x 145 x 256 mm
- Weight: 4.2Kgs

Operating modes: 1, Dimming 0-100%
 2, DMX
 3, Master/slave
 4, Channel select
 5, Dimming curves

Overview:

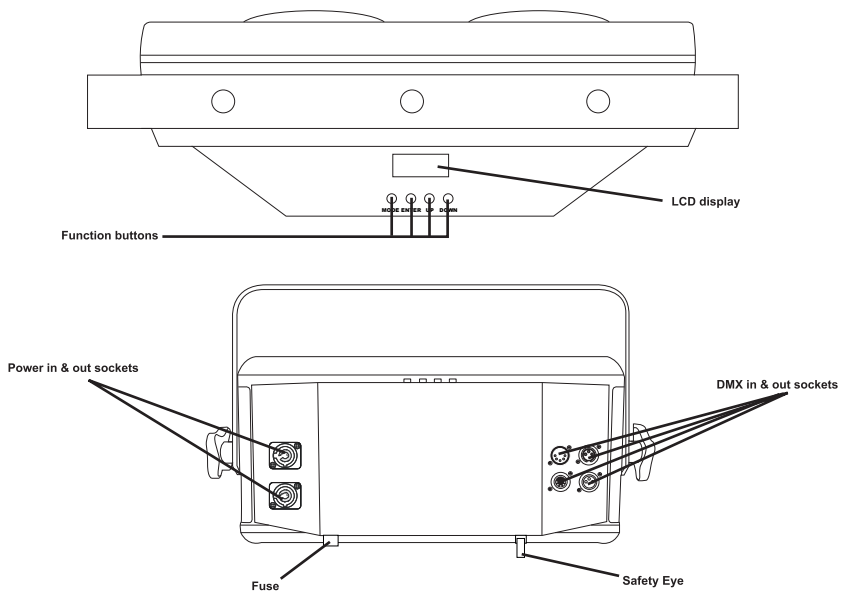

Operation:

1. Dimming Mode

To enter the dimming mode, press the “MODE” button to show “DIMMER” on the LCD display. Now press the “ENTER” button and use the “UP” and “DOWN” buttons to set the brightness from 00-99. Now press the “ENTER” button again to add strobe and use the “UP” and “DOWN” buttons to change the flash speed from 00-99.

NOTE: C:99 = Dimming (00 = off, 99 = full on), F-99 = Flash (00 = off, 99 = fast)

After making your selection, press the “ENTER” button to confirm it.

2. Slave Mode

To enter slave mode, press the “MODE” button to show “SLAVE” on the LCD display. Now the unit will follow in sequence with the master unit.

3. Dimming Curve Mode

The 200W blinder includes 4 dimming curves for both LED and halogen.

The first is a Halogen emulation mode with a very smooth slow dimming and a small delay.

The second is an LED response with faster dimming and no delay.

To enter the dimming curve mode, press the “MODE” button to show “DIMMER CURVE” on the LCD display. Now press the “ENTER” button and use the “UP” and “DOWN” buttons to select between the 4 dimming curves from 01-08.

1-4 are for halogen response type : 01 = Linear, 02 = Square, 03 = Inverse square, 04 = S-curve.
5-8 are for LED response type: 05 = Linear, 06 = Square, 07 = Inverse square, 08 = S-curve.

When you are happy with your setting, press the “ENTER” button to confirm it.

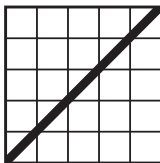

LINEAR

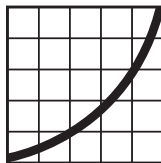

SQUARE

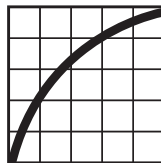

INVERSE SQUARE

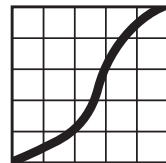

S-CURVE

LINEAR: the increase in light intensity appear to be linear as DMX value is increased.

SQUARE: light intensity control is finer at low levels and coarser at high levels

INVERSE SQUARE: light intensity control is coarser at low levels and finer at high levels

S-CURVE: light intensity control is fine at low levels and high levels and coarser at medium levels.

4. Channel Mode

To enter the channel mode, first press the mode button to show “CHANNEL” on the LCD display. Now press the “ENTER” button and use the “UP” and “DOWN” buttons to select 1, 2 or 4 channel modes.

5. DMX Mode

To enter the DMX mode, press the “MODE” button to show “DMX MODE” on the LCD display. Now press the “ENTER” button and use the “UP” and “DOWN” buttons to select the DMX address from 001-512.

After making your selection, press the “ENTER” button to confirm it.

DMX Charts

1 channel mode:

Channel	Value	Function
CH1	0-255	Dimming 0-100% using the curve set on the fixture

2 channel mode:

Channel	Value	Function
CH1	0-255	Dimming 0-100% using the curve set on the fixture
CH2	0-255	Strobe 0-100% (slow to fast)

4 channel mode:

Channel	Value	Function
CH1	0-255	Left spot dimming 0-100%
CH2	0-255	Right Spot dimming 0-100%
CH3	0-255	Strobe (slow to fast)
CH4	0-15	Dimmer curve and response selected on fixture
	16-45	Dimmer curve Linear response halogen
	46-75	Dimmer curve Square response halogen
	76-105	Dimmer curve Inverse Square response halogen
	106-135	Dimmer curve S response halogen
	136-165	Dimmer curve Linear response LED
	166-195	Dimmer curve Square response LED
	196-225	Dimmer curve Inverse Square response LED
	226-255	Dimmer curve S response LED

DMX-512:

- DMX (Digital Multiplex) is a universal protocol used as a form of communication between intelligent fixtures and controllers. A DMX controller sends DMX data instructions from the controller to the fixture. DMX data is sent as serial data that travels from fixture to fixture via the DATA "IN" and DATA "OUT" XLR terminals located on all DMX fixtures (most controllers only have a data "out" terminal).

DMX Linking:

- DMX is a language allowing all makes and models of different manufactures to be linked together and operate from a single controller, as long as all fixtures and the controller are DMX compliant. To ensure proper DMX data transmission, when using several DMX fixtures try to use the shortest cable path possible. The order in which fixtures are connected in a DMX line does not influence the DMX addressing. For example; a fixture assigned to a DMX address of 1 may be placed anywhere in a DMX line, at the beginning, at the end, or anywhere in the middle. When a fixture is assigned a DMX address of 1, the DMX controller knows to send DATA assigned to address 1 to that unit, no matter where it is located in the DMX chain.

DATA Cable (DMX cable) requirements (for DMX operation):

- The 200W Blinder can be controlled via DMX-512 protocol. The DMX address is set on the back of the unit. Your unit and your DMX controller require a standard 3 or 5-pin XLR connector for data input/output (figure 1).

Figure 1



Also remember that DMX cable must be daisy chained and cannot be split.

Notice:

• Be sure to follow figures 2 & 3 when making your own cables. Do not connect the cable's shield conductor to the ground lug or allow the shield conductor to come in contact with the XLR's outer casing. Grounding the shield could cause a short circuit and erratic behaviour.

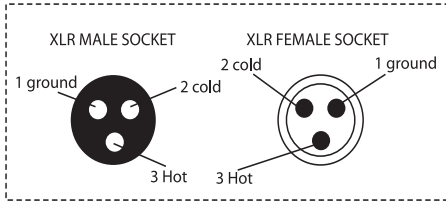
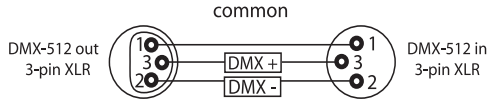

FIGURE 3

XLR Pin Configuration
Pin 1 = Ground
Pin 2 = Negative
Pin 3 = Postive

FIGURE 2

Special Note: Line termination:

• When longer runs of cable are used, you may need to use a terminator on the last unit to avoid erratic behaviour.

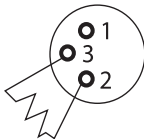

Termination reduces signal transmission problems and interference. It is always advisable to connect a DMX terminal, (resistance 120 Ohm 1/4 W) between pin 2 (DMX-) and pin 3 (DMX+) of the last fixture.

Using a cable terminator CABL90 (3-pin) or CABL89 (5-pin) will decrease the possibilities of erratic behaviour.

5-Pin XLR DMX Connectors:

• Some manufactures use 5-pin XLR connectors for data transmission in place of 3-pin. 5-Pin XLR fixtures may be implemented in a 3-pin XLR DMX line. When inserting standard 5-pin XLR connectors in to a 3-pin line a cable adaptor must be used. The Chart below details the correct cable conversion.

