



Light is essential
Products for medical devices

Light is OSRAM

OSRAM

The right light for your application



Surgical Lighting

Benefits

Instant brilliant light and light output over life with a constant color temperature and excellent color rendering.

Halogen

- 64291 XIR®
- 64292 XIR®
- 64668 XIR®
- 64638 HLX®
- 64642 HLX®
- 64643
- 64647
- 64650



Analyzing

Benefits

Effective and optimized illumination for analyzing and diagnostics to identify the molecular structure of a compound or to determine its purity. The filament with tight tolerances provides an excellent and uniform illumination of small areas with constant and brilliant light over the entire lifetime. Customized solutions on request.

Discharge/Halogen

- HBO®
- XBO®
- HXP®
- 64258
- 64259
- 64623 HLX®
- Halogen modules



Purification with UV Light

Benefits

Long life and high germicidal efficiency for surface sterilization, air and water purification.

Discharge

- PURITEC® HNS®



Medical Fiber Optics

Benefits

Illumination of human organs or tissue containing a well-balanced spectral characteristic and high color rendering. Focused light beam for easy and efficient coupling into light guides with small diameters. Optimized for endoscopy and surgical headlamps.

Discharge/Halogen

- XBO®
- 64627 HLX®
- 64634 HLX®
- 64653 HLX®



Bilirubin therapy lighting

Benefits

As part for medical devices OSRAM BLUE is the perfect solution for the treatment of jaundice. Its compact design is suitable for mobile equipment and hand-held luminaires. It works emission-free and with low energy consumption.

Discharge

- DULUX® S BLUE 9W/71
- DULUX® L BLUE 18W/71
- L BLUE 18W/71



Microscopy

Benefits

Illumination for microscopy visualization in medical and life science systems. Providing white light and a wide range of wavelenghts for fluorescence applications. Optimized for surgical, diagnostic, and inspection microscopy.

Discharge/Halogen

- HBO®
- XBO®
- HXP®
- Halogen lamps without reflector

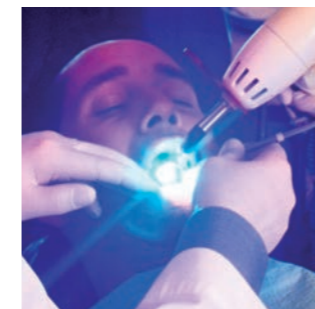

Dental curing

Benefits

Exposure of light-activated composites and adhesives. High irradiation level required for short curing times in dental applications.

Discharge

- HBO®
- HXP®

Halogen

- 64613
- 64617/64617S
- 64624

The right light for your application

Halogen lamps

Halogen HLX® lamp family



- HLX® tungsten halogen low-voltage lamp with or without a reflector
- Xenon-gas-filled lamps have up to 10 % higher luminous efficacy than standard lamps
- Instant light
- Dimmable
- Mercury-/ Ozone-free

Infrared-coated capsule XIR®



- Tungsten halogen capsule filled with xenon gas and in addition with infrared (IR) coating on the glass bulb for maximum energy efficiency
- IR capsule produces up to 30 % higher luminous efficacy than standard lamps with the same characteristics (wattage and lamp life)
- Mercury-/ Ozone-free

Halogen Lamp Modules – Customized Solutions



- Various lamp types can be combined with a customized lamp base
- Automatic computer-controlled production process with very tight tolerances
- Lamp is optimally adjusted in the system after the replacement, no readjustment necessary
- Special customized solutions on request

Discharge lamps

XBO® 75 W, 100 W, 150 W



- Xenon discharge lamp for DC operation
- Color rendering index > 95
- Short arc
- Hot restart

Optimized UV Light HBO®

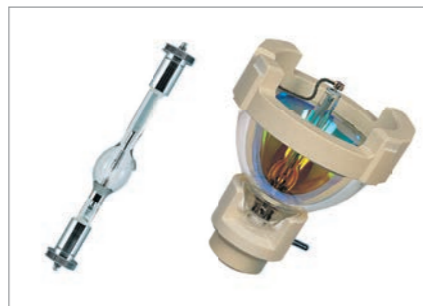

- Mercury discharge lamp for DC/AC operation at constant power
- Short arc

Optimized UV & Blue Light with Long Life HXP® R 120 W UV



- Mercury discharge lamp for AC operation at constant power
- Short arc
- Long average life: up to 2.000 hours
- Focus diameter of approx. 5 mm
- Reflector of HXP® R 120 W UV coated for maximum reflection in 320 ... 500 nm range
- ECG / lamp system

Discharge lamps

UV, Blue & White Light with Long Life HXP® R 120 W VIS, 200 W



- Mercury discharge lamp for AC operation at constant power
- Short arc
- Long average life: up to 2.000 hours
- Focus diameter of approx. 5 mm
- Reflector coated for maximum reflection in blue and visible spectral range
- ECG / lamp system

Excellent Xenon Light XBO® 100 W, 180 W, R 300 W



- Xenon discharge lamp for DC operation
- Color rendering index > 95
- Short arc
- Focus diameter of approx. 5 mm
- Reflector coated for maximum reflection in visible spectral range
- Ozone-free
- Hot restart

Linear PURITEC® HNS® UV-C Light



- Efficient at disinfecting air, water and surfaces
- Effective and environmentally friendly disinfection without chemicals
- Low mercury content
- Long lifetime thanks to special high-quality coating of the glass bulb
- 4 W - 60 W

Discharge lamps

Compact PURITEC® HNS® UV-C Light



- Efficient at disinfecting air, water and surfaces
- Effective and environmentally friendly disinfection without chemicals
- Low mercury content
- Long lifetime thanks to special high-quality coating of the glass bulb
- 5 W - 95 W

OSRAM BLUE lamps



- Low mercury content
- Long lifetime thanks to special high-quality coating of the glass bulb
- High quality

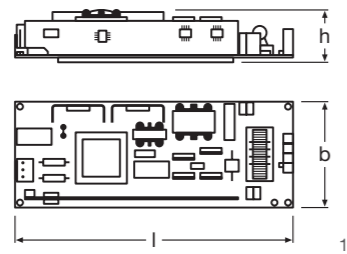

ECG for medical applications

Product name	GTIN (EAN)	kV START	W	l (mm)	b (mm)	h (mm)	AC/DC	50/25	1
PT-VIP 4AC/380 O3 DIM	4008321964830	5 ²⁾	200	135	50	27	DC/AC ¹⁾	50	1
PT-VIP 2AC/380 O1 DIM 120 EN	4008321040855	20 ²⁾	120	150	60	32	DC/AC ¹⁾	25	

1) Input/Output
2) Maximum

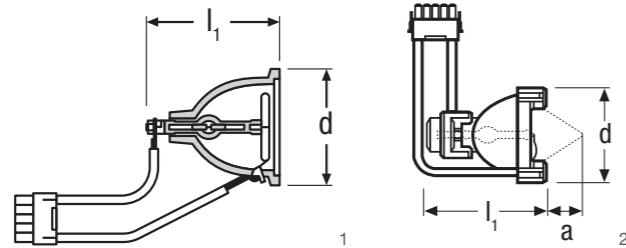
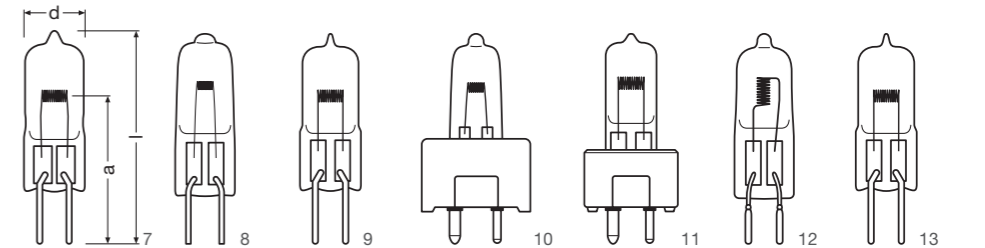
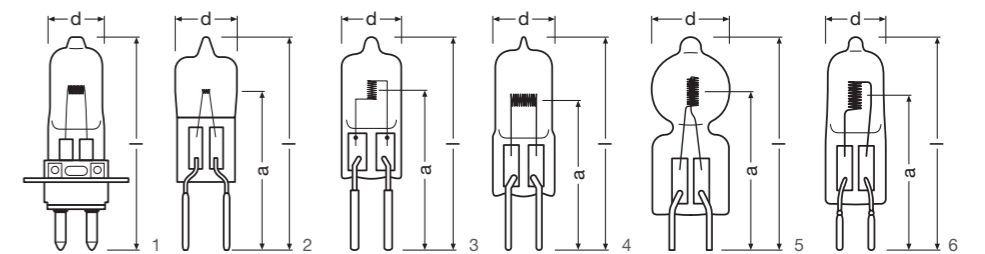

HXP® Mercury short-arc lamps, long life

Product name	GTIN (EAN)	W	V	A	AC/DC	t[h]	d (mm)	l1 max. (mm)	l2 (mm)	Forced	p20	50	1
HXP R 120 W/17 C ¹⁾	4050300786476	120 ⁴⁾	70...95 ⁵⁾	1.5	AC	2000	65	77	17.3	Forced	p20	50	1
HXP R 120 W/45 C VIS ¹⁾	4050300882772	120 ⁴⁾	60...90 ⁵⁾	1.4	AC	2000	67	77	45	Forced	p20	2	2
HXP R 120 W/45 C UV ¹⁾	4050300666525	120 ⁴⁾	60...90 ⁵⁾	1.4	AC	2000	67	77	45	Forced	p20	2	2
HXP R 200 W/45 M ²⁾	4008321180070	200 ⁴⁾	60...96 ⁵⁾	3.4	AC	2000	67	77	45	Forced	p20	2	2
HXP R 206 W/45C ³⁾	4008321331472	200 ⁴⁾	48...82 ⁵⁾	3.4	AC	1000	67	77	45	Forced	p20	2	2

1) To be operated with PT-VIP 2AC/380 O1 DIM 120 VS25
2) To be operated with PT-VIP 4AC/380 O3 200 DIM VS50
3) To be operated with PT-VIP 4AC/380 O3 DIM 206 VS50
4) not relevant
5) Initial voltage range

Low-voltage halogen lamps without reflector

Product name	GTIN (EAN)	ANSI	LIF	W	V	t[h]	d (mm)	l (mm)	LCL a (mm)	1.3*0.8	Any	PG22	B	30	1
64222	4050300327273			10 ⁶⁾	6	300	9	44	14	1.3*0.8	Any	PG22	B	30	1
64223	4008321107039		M/43	10 ⁶⁾	6	300	9	38	24	1.5*0.7	Any	G4	B	40	2
64225	4050300006758	ESA/FHS	M/29	10 ⁶⁾	6	100	9.5	31	19.5	1.7*0.65	s90	G4	B	40	2
64250 HLX	4050300012407	ESB	M/30	20 ⁶⁾	6	100	9	31	19.4 ²⁾	2.3*0.8	Any	G4	B	40	2
64251 HLX	4050300338316			20 ⁶⁾	6	100	9	40	14	2.3*0.8	Any	PG22	B	30	1
64265 HLX	4008321107053			30 ⁶⁾	6	100	9	31	19.5	1.6*1.6	Any	G4	B	40	2
64275	4050300258690		M/137	35 ⁶⁾	6	50	9	35	26 ²⁾	1.3*1.6	Any	G4	C	40	3
64258	4050300285153			20 ⁶⁾	12	2000	9.5	30	19.5 ²⁾	3.25*0.7 ⁴⁾	s90	G4	C	40	2
64259	4008321352569			20 ⁶⁾	12	1500	9.5	30	19.5 ²⁾	1.9*2	s90	G4	B	40	4
64260	4050300099798		M/185	30 ⁶⁾	12	50	9	40	14	2.6*1.3	Any	PG22	B	30	1
64261 HLX	4050300220529		M/130	30 ⁶⁾	12	50	11.5	44	30	2.6*1.3	Any	G6.35	B	40	8
64602	4008321107077		M/134	50 ⁶⁾	12	1100	11.5	44	30	3.0*3	s90	G6.35	C	40	4
64610 HLX	4050300006697	BRL	A1/220	50 ⁶⁾	12	50	11.5	44	30 ²⁾	3.3*1.6	s90	G6.35	B	40	8
64611 HLX	4008321107091			50 ⁶⁾	12	100	11.5	44	30	3.3*1.6	s90	G6.35	B	40	8
62138 HLX	4050300242958			100 ⁶⁾	12	50	11.5	37	27	2.4*1.8	p90/p15	G6.35	B	40	3
64621 HLX	4050300535531			100 ⁶⁾	12	2000	11.5	48	18	4.7*2.7	s90	PG22	B	30	1
64623 HLX	4050300012018	EVA	M/28	100 ⁶⁾	12	2000	11.5	44	30	4.7*2.7	s90	GY6.35	B	40	9
64625 HLX	4050300006703	FCR	A1/215	100 ⁶⁾	12	50	11.5	44	30 ²⁾	4.2*2.3	s90	GY6.35	B	40	9
64628	4008321099549	FDT	A1/261	100 ⁶⁾	12	50	13	57	27	4.2*2.3	s90	GY9.5	B	12	10
64626 HLX ¹⁾	4050300006765	EHE	A1/45	100 ⁶⁾	12	50	11.5	48	18	4.2*2.3	s90	PG22	B	30	1
64291 XIR	4008321330550			40 ⁶⁾	22.8	800	12	44	30 ³⁾	3.9*1.4	h90	G6.35	B	40	5
64650	4008321107138			50 ⁶⁾	22.8	1200	13	44	30	2.0*5	Any	G6.35	C	40	6
64668 XIR	4008321331182			80 ⁶⁾	22.8	400	14	44	30 ²⁾	2.2*5.5	h90	G6.35	B	40	5
64292 XIR	4008321330598			150 ⁶⁾	22.8	600	14	44	30 ²⁾	2.8*6.7	s90	G6.35	B	40	5
64638 HLX	4050300283050			100 ⁶⁾	24	300	13	50	30	5.3*2.6	Any	G6.35	B	40	9
64647	4008321107114			120 ⁶⁾	24	700	13	44	30	2.3*6.4	Any	G6.35	B	40	3
64640 HLX	4050300006727	FCS	A1/216	150 ⁶⁾	24	50	11.5	50	31.7 ²⁾	5.8*2.9	s90	G6.35	B	40	9
64641 HLX	4050300048260			150 ⁶⁾	24	2000	11.5	50	32	3.0*6	s135	G6.35	D	40	9
64642 HLX	4050300012025	FDV	M/184	150 ⁶⁾	24	300	11.5	50	31.7 ²⁾	6.0*3.2	s90	G6.35	B	40	9
64643	4008321099648	FDS	A1/262	150 ⁶⁾	24	100	15	57	33.5	6.0*3	s90	GY9.5	B	12	11
64652 HLX	4052899100916			250 ⁶⁾	24	50	11.5	46	31.8	2.7*5	p90/p15	GX5.3	B	40	12
64655 HLX	4050300006734	EHL	A1/223	250 ⁶⁾	24	50	12.5	55	33	7.0*3.5	s90	G6.35	B	40	13
64657 HLX	4050300012001	EVC	M/33	250 ⁶⁾	24	300	13.5	55	33	8.0*4	s90	G6.35	B	40	13
64656 HLX	4050300023120	FNT		275 ⁶⁾	24	75	13.5	55	33	7.0*3.5	s90	G6.35	B	40	13
64654 HLX ¹⁾	4008321241399			250 ⁶⁾	24	300	13.5	67	35	8.0*4	s90	GY9.5	B	12	11
64663 HLX	4050300006741	EVD	A1/239	400 ⁶⁾	36	50	15	60	36	9.3*4.9	s90	G6.35	B	40	13
64664 HLX	4008321241474		A1/270	400 ⁶⁾	36	150	18	57	36	10.0*5 ⁵⁾	s105	G6.35	B	40	13
64665 HLX	4008321833815		A1/166	400 ⁶⁾	36	300	18	60	36	10.5*5.3	s90	G6.35	B	40	13
64633 HLX	4050300006710	BRJ	A1/234	150 ⁶⁾	15	50	11.5	44	30	3.0*4.8	s90	G6.35	B	40	9
62139 HLX	4008321746276			150 ⁶⁾	12.8	300	13	50	32	6.0*3.2	h90	G6.35	B	40	7

1) Available on request
2) ±0.3 mm
3) ±0.5 mm
4) Restricted tolerances 3.5±0.25*0.8±0.10
5) Round-core double coil
6) not relevant

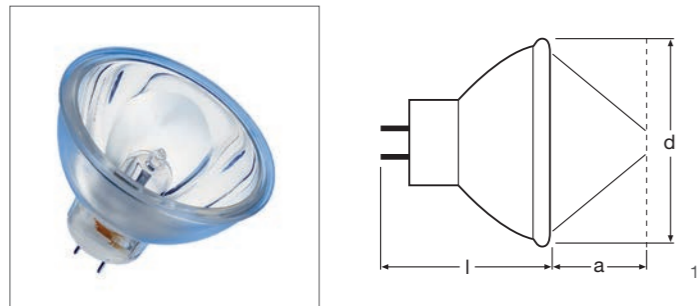

Halogen lamps with reflector MR16

Product name	GTIN (EAN)	ANSI	LIF	W	V	t[h]	φ [mm]	l [mm]	a [mm]	Icons
64607	4050300006789	EFM	A1/229	50 ²⁾	8	50	51	42	32	p90/p15 Aluminum GZ6.35 B 20 1
64615 HLX	4050300006796	EFN	A1/230	75 ²⁾	12	50	51	42	32	p90/p15 Dichroic GZ6.35 B 20 1
64619	4050300017273	EPX		90 ²⁾	14.5	500	51	45	155	p90 Dichroic GX5.3 50 1
64627 HLX	4050300006802	EFP	A1/231	100 ²⁾	12	50	51	42	32	p90/p15 Dichroic GZ6.35 B 20 1
64629	4050300943169	FFP-6		100 ²⁾	12	600	51	42	32	p90/p15 Dichroic GZ6.35 B 20 1
64637	4008321352071	EBV	A1/271	100 ²⁾	12	1500	51	42	32	s120 Dichroic GZ6.35 B 20 1
64620	4050300797397	EFR-5		150 ²⁾	15	500	50	42	32	p90/p15 Dichroic GZ6.35 B 20 1
64634 HLX	4050300006819	EFR	A1/232	150 ²⁾	15	50	51	42	32	p90/p15 Dichroic GZ6.35 B 20 1
64635 HLX ¹⁾	4050300238807			150 ²⁾	15	50	51	45	19	Any Gold GZ6.35 20 1
93637	4050300350097	EJV		150 ²⁾	21	100	51	44.5	44.5	s90 Dichroic GX5.3 E 24 1
93638	4050300456843	EKE		150 ²⁾	21	200	51	44.5	44.5	s90 Dichroic GX5.3 E 24 1
93653	4050300636450	ELC-3		250 ²⁾	24	300	51	44.5	35	Any Dichroic GX5.3 E 24 1
64659	4008321197795	ELC-10		250 ²⁾	24	1000	51	44.5	35	Any Dichroic GX5.3 B 20 1
93506	4050300349930	ENH		250 ²⁾	120	175	51	44.5	152.5	s90 Dichroic GY5.3 E 24 1
93518	4050300350059	ELH		300 ²⁾	120	35	51	45	152.5	s90 Dichroic GY5.3 E 24 1

1) Infra-red lamp; temperature at the focal point approximately 1300 °C
2) not relevant

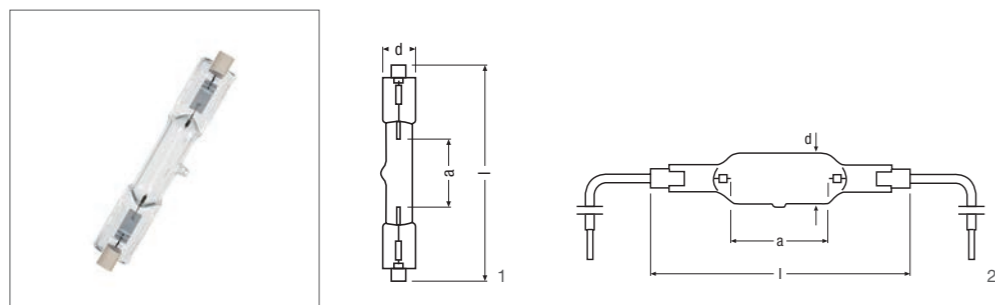

SUPRATEC® HTC/HTT Ultraviolet lamps

Product name	GTIN (EAN)	W	V	UVA/W	UVB/W	φ [mm]	l [mm]	a [mm]	Icons
HTT 150-211	4008321912848	150 ¹⁾	230	22	6	10	57.6	10	R7s 25 1
HTC 400-241	4008321694676	460 ¹⁾	230	82	12	14	104	33	R7s 25 1
HTC 1000-241	4008321694690	1000 ¹⁾	230	240	40	28	140	48	KY10s 25 2
HTC 2000-349	4008321739704	2000 ¹⁾	400	490	60	30	196	104	KY10s 25 2

1) not relevant

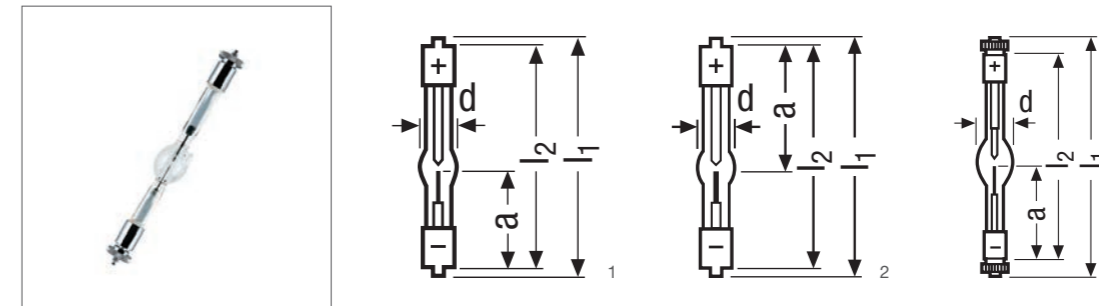

XBO® Xenon short-arc lamps without reflector

Product name	GTIN (EAN)	W	V	A	t[h]	l [mm]	l1 max [mm]	LCL a [mm]
XBO 75 W/2	4050300508801	64...86	12...16 ⁶⁾	4.9...5.9	400	90	82	37 ⁹⁾
XBO 75 W/2 OFR ¹⁾	4050300508825	64...86	12...16 ⁶⁾	4.9...5.9	400	90	82	37 ⁹⁾
XBO 100 W OFR ¹⁾	4008321386328	85...115	12.8...14.4 ⁶⁾	7.0...7.4	500	90	82	44.5 ¹⁰⁾
XBO 150 W/CR OFR ¹⁾	4050300508788	125...180	15...18 ⁶⁾	8.5 ⁷⁾	3000 h / 1200 ⁸⁾	150	127	57 ⁹⁾
XBO 150 W/1	4050300508344	130...175	17...21 ⁶⁾	7.5 ⁷⁾	1200	150	127	57 ⁹⁾
XBO 150 W/4 ²⁾	4050300508382	130...175	17...21 ⁶⁾	7.5 ⁷⁾	1200	150	127	57 ⁹⁾

Product name	GTIN (EAN)	Icons	Icons	Icons	Icons	Icons	Icons
XBO 75 W/2	4050300508801	Convection	s100 ³⁾	SFa9-2	SFa7.5-2	DC	10 1
XBO 75 W/2 OFR ¹⁾	4050300508825	Convection	s100 ³⁾	SFa9-2	SFa7.5-2	DC	10 1
XBO 100 W OFR ¹⁾	4008321386328	Convection	s100 ³⁾	SFa9-2	SFa7.5-2	DC	10 2
XBO 150 W/CR OFR ¹⁾	4050300508788	Forced	s15 ⁴⁾	SFc12-4	SFcX12-4	DC	10 3
XBO 150 W/1	4050300508344	Forced	s15 ⁴⁾	SFc12-4	SFcX12-4	DC	10 3
XBO 150 W/4 ²⁾	4050300508382	Forced	s15 ⁴⁾	SFc12-4	SFcX12-4	DC	10 3

1) OFR = Ozone-free version
2) Lamp uses a special quality of quartz glass, known as SUPRASIL, which – in comparison to conventional quartz – provides higher transmission below 250 nm
3) If vertical, then anode on top; up to 10° below horizontal, cathode on top
4) For vertical burning position: anode (+) on top
5) Anode (+) on top
6) Initial voltage range
7) Operation with rated current recommended
8) In vertical burning position / In horizontal burning position
9) Distance from end of base to tip of electrode (cold)
10) Distance from end of base to tip of anode (cold)

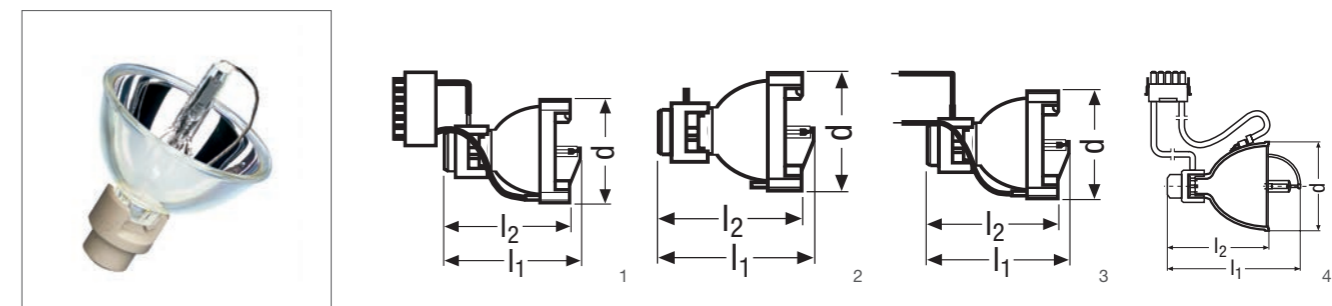

XBO® Xenon short-arc lamps with reflector 75...300 W

Product name	GTIN (EAN)	W	V	A	t[h]	Icons	Icons	Icons	Icons	Icons	Icons	Icons
XBO R 100 W/45 C ¹⁾	4050300367767	85...115	12...14 ²⁾	7.0...7.4	500	77	45	Forced	p20	DC	2	1
XBO R 100 W/45 OFR ¹⁾	4050300317205	85...115	12...14 ²⁾	7.0...7.4	500	77	45	Forced	p20	DC	2	2
XBO R 101 W/45 C OFR ¹⁾	4050300388458	85...115	12...14 ²⁾	7.0...7.4	500	77	45	Forced	p20	DC	2	3
XBO R 180 W/45 ¹⁾	4050300432175	150...210	12.8...14.8 ²⁾	11.75...12.25	500	81.5	45	Forced	p20	DC	2	2
XBO R 180 W/45 C OFR ¹⁾	4050300432199	150...210	12.8...14.8 ²⁾	11.75...12.25	500	81.5	45	Forced	p20	DC	2	1
XBO R 181 W/45 C ¹⁾	4050300450872	150...210	12.8...14.8 ²⁾	11.75...12.25	500	81.5	45	Forced	p20	DC	2	3
XBO R 300 W/60 C OFR ¹⁾	4008321137722	250...300	16...20 ²⁾	18	1000	80	60	Forced	p20	DC	2	4

1) OFR = Ozone-free version
2) Initial voltage range

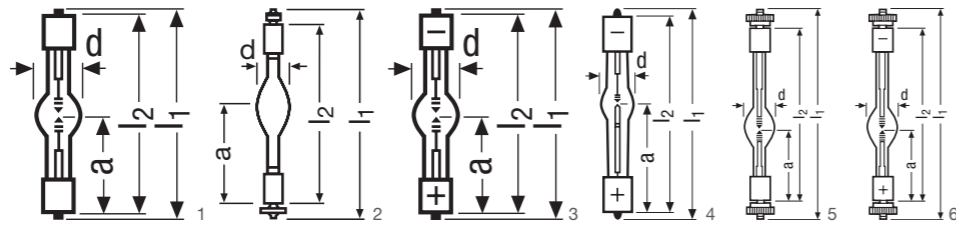

HBO® Mercury short-arc lamps without reflector 50...200 W

Product name	GTIN (EAN)	W	V	A	AC/DC	t [h]	d [mm]	
HBO 50 W/AC 39 V	4050300507132	50	39...45 ¹⁾	1.1...1.3 ⁶⁾	AC	100	10	47 ¹⁾
HBO 50 W/AC 34 V	4050300507118	50	34...39 ¹⁾	1.3...1.5 ⁶⁾	AC	100	10	47 ¹⁾
HBO 50 W/3	4050300506692	50	20...26 ¹⁾	1.9...2.5 ⁶⁾	DC	200	9	47 ¹⁾
HBO 100 W/2	4050300507095	100	6 ¹⁾	4.3...5.6 ⁶⁾	DC	200	10	82 ¹⁾
HBO 103 W/2	4050300382128	100	17...25 ¹⁾	4.0...5 ⁶⁾	DC	300	10	82 ¹⁾
HBO 200 W/4	4050300506715	200	54...63 ¹⁾	3.0...3.7 ⁶⁾	AC	200	17	102 ¹⁾
HBO 202 W/4	4050300507156	200	57...65 ¹⁾	3.6 ⁶⁾	AC	200	18	102 ¹⁾
HBO 200 W/2 57 V	4050300508153	200	57...65 ¹⁾	3.0...3.5 ⁶⁾	AC/DC	400 h / 200 ⁸⁾	17	102 ¹⁾
HBO 200 W/DC 57 V	4050300506791	200	48...65 ¹⁾	3.0...4.3 ⁶⁾	DC	1000	17	102 ¹⁾
HBO 200 W/DC TM	4008321137623	200	57...65 ¹⁾	3.0...4.3 ⁶⁾	DC	400	17	102 ¹⁾

Product name	GTIN (EAN)	H max. [mm]	LCL a [mm]					
HBO 50 W/AC 39 V	4050300507132	47 ¹⁾	22 ²⁾	s45 ³⁾	SFa6-2	SFa6-2	10	1
HBO 50 W/AC 34 V	4050300507118	47 ¹⁾	22 ²⁾	s45 ³⁾	SFa6-2	SFa6-2	10	2
HBO 50 W/3	4050300506692	47 ¹⁾	22 ²⁾	s45 ³⁾	SFa8-2	SFa6-2	10	3
HBO 100 W/2	4050300507095	82 ¹⁾	43 ²⁾	s90 ⁴⁾	SFa9-2	SFa7.5-2	10	4
HBO 103 W/2	4050300382128	82 ¹⁾	43 ²⁾	s90 ⁴⁾	SFa9-2	SFa7.5-2	10	4
HBO 200 W/4	4050300506715	102 ¹⁾	40 ²⁾	s20 ⁵⁾	SFc10-4	SFc10-4	10	5
HBO 202 W/4	4050300507156	102 ¹⁾	40 ²⁾	s15 ⁵⁾	SFc10-4	SFc10-4	10	5
HBO 200 W/2 57 V	4050300508153	102 ¹⁾	40 ²⁾	s90 ⁴⁾	SFc10-4	SFc10-4	10	6
HBO 200 W/DC 57 V	4050300506791	102 ¹⁾	40 ²⁾	s90 ⁴⁾	SFc10-4	SFc10-4	10	6
HBO 200 W/DC TM	4008321137623	102 ¹⁾	40 ²⁾	s90 ⁴⁾	SFc10-4 ⁷⁾	SFc10-4 ⁷⁾	10	6

- 1) Maximum
- 2) Distance from end of base to tip of anode (cold)
- 3) Observe "UP" marking
- 4) Anode underneath
- 5) Reference base pointing downwards (shorter shaft)
- 6) Initial electrical values
- 7) With 8-32 UNC-3 B thread
- 8) Reduced lifespan in AC operation

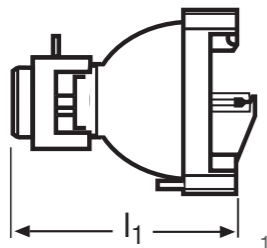

HBO® Mercury short-arc lamps with reflector 100 W

Product name	GTIN (EAN)	W	V	A	AC/DC	t [h]	UVA/W	d [mm]	H max. [mm]	LCL a [mm]				
HBO R 103 W/45	4050300405957	100	20...25 ¹⁾	4.0...5 ¹⁾	DC	300	3.8 W / 5 ²⁾	68	77	45	p20	Pin	Pin	2 1

- 1) Initial electrical values
- 2) Aperture 3 mm round / Aperture 5 mm round

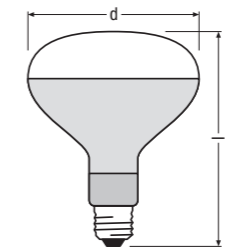

ULTRA VITALUX

Product name	GTIN (EAN)	W	V	t [h]	UVA/W	UVB/W	d [mm]	l [mm]					
ULTRA VITALUX 300 W 230 V E27	4008321543929	300 ¹⁾	230	1000	13.6	3	127	185	Any	E27	6	1	

1) not relevant

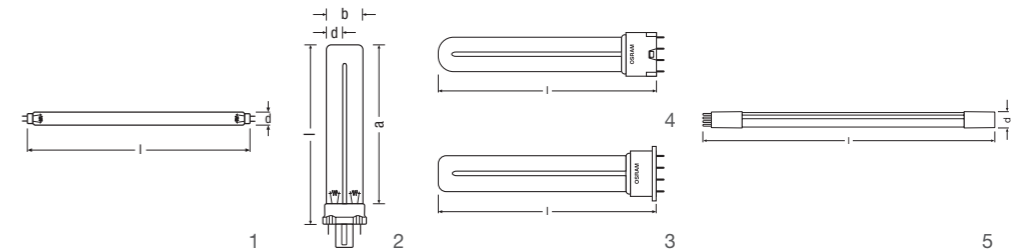

PURITEC® HNS® Germicidal ultraviolet lamps

Product name	GTIN (EAN)	W	A	d [mm]	l [mm]		UVC/W			
HNS 4 W G5	4008321378316	4 ²⁾	0.17	16	136	G5	0.9	25	1	
HNS 6 W G5	4008321378330	6 ²⁾	0.16	16	212	G5	1.7	25	1	
HNS 8 W G5 G5	4008321378385	7 ²⁾	0.15	16	288	G5	2	25	1	
HNS 11W G5	4008321468796	11 ²⁾	0.41	16	212	G5	2.5	25	1	
HNS 16 W G5	4008321620774	16 ²⁾	0.43	16	288	G5	4	25	1	
HNS S 5 W G23 ¹⁾	4008321229946	5 ²⁾	0.18	28	108	G23	1.3	10	2	
HNS S 7 W G23 ¹⁾	4050300941202	7 ²⁾	0.18	28	135.5	G23	1.8	10	2	
HNS S 9 W G23 ¹⁾	4050300941226	9 ²⁾	0.18	28	165.5	G23	2.5	10	2	
HNS S 11 W G23 ¹⁾	4050300941240	11 ²⁾	0.16	28	235.5	G23	3	10	2	
HNS S/E 7 W 2G7	4008321383891	6.50 ²⁾	0.18	28	112	2G7	1.9	10	3	
HNS S/E 9 W 2G7	4008321384911	8 ²⁾	0.17	28	142	2G7	2.5	10	3	
HNS S/E 11 W 2G7	4008321384935	11 ²⁾	0.15	28	212	2G7	3.6	10	3	
HNS S 13 W GX23	4052899040410	13.40 ²⁾	0.28	28	179	GX23	3.4	10		
HNS L 18 W 2G11	4008321220431	18 ²⁾	0.38	40	214	2G11	5.5	10	4	
HNS L 24 W 2G11	4008321220561	24 ²⁾	0.35	40	314.5	2G11	7.3	10	4	
HNS L 36 W 2G11	4008321220684	36 ²⁾	0.44	40	408	2G11	10.8	10	4	
HNS L 55 W 2G11	4052899012394	55 ²⁾	0.55	40	533	2G11	17	10	4	
HNS L 60 W 2G11	4052899012462	60 ²⁾	0.8	40	408	2G11	19	10	4	
HNS L 95 W 2G11	4052899012509	95 ²⁾	0.8	40	533	2G11	27	10	4	
HNS 15W G13	4008321770271	15 ²⁾	0.33	26	438	G13	4	25	1	
HNS 30W G13	4008321770301	30 ²⁾	0.36	26	895	G13	12	25	1	
HNS 36W G13	4052899084018	36 ²⁾	0.44	26	1200	G13	15	25	1	
HNS 55W G13	4052899083936	55 ²⁾	0.77	26	895	G13	18	25	1	
HNS 16W 4P SE	4052899437586	16 ²⁾	0.40	16	320.3	4P SE	4	40	5	
HNS 20W 4P SE	4052899437562	20 ²⁾	0.45	16	430	4P SE	6	40	5	
HNS 36W 4P SE	4052899437630	36 ²⁾	0.43	16	845.4	4P SE	14	40	5	

1) UV irradiance 253.7 nm measured at a distance of 1 m at mid-lamp level, at 20 ° C ambient temperature, free-burning. Between 0.3...3.0 m, the irradiance is inversely proportional to the square of the distance
2) not relevant

If you are interested in learning more about OSRAM lamps portfolio for medical applications, please visit our corporate website:

www.osram.com/pia

OSRAM GmbH

Head Office:

Marcel-Breuer-Straße 6
80807 Munich
Phone +49 (0)89-6213-0
Fax +49 (0)89-6213-20 20
www.osram.com

Professional and Industrial
Applications:

Nonnendammallee 44
13629 Berlin
E-mail: webmaster@osram.com

OSRAM