



DOUGHTY ENGINEERING LTD

DATA SHEET

TITLE: 28mm TO 16mm ADAPTER
SPIGOT - M10

PART NOS:
T74307

MATERIAL:
STEEL

WEIGHT:

SWL:

FINISH:
CHROME PLATED

NOTES:

**STRICTLY
FOR
REFERENCE
PURPOSES
ONLY**



THIRD ANGLE PROJECTION

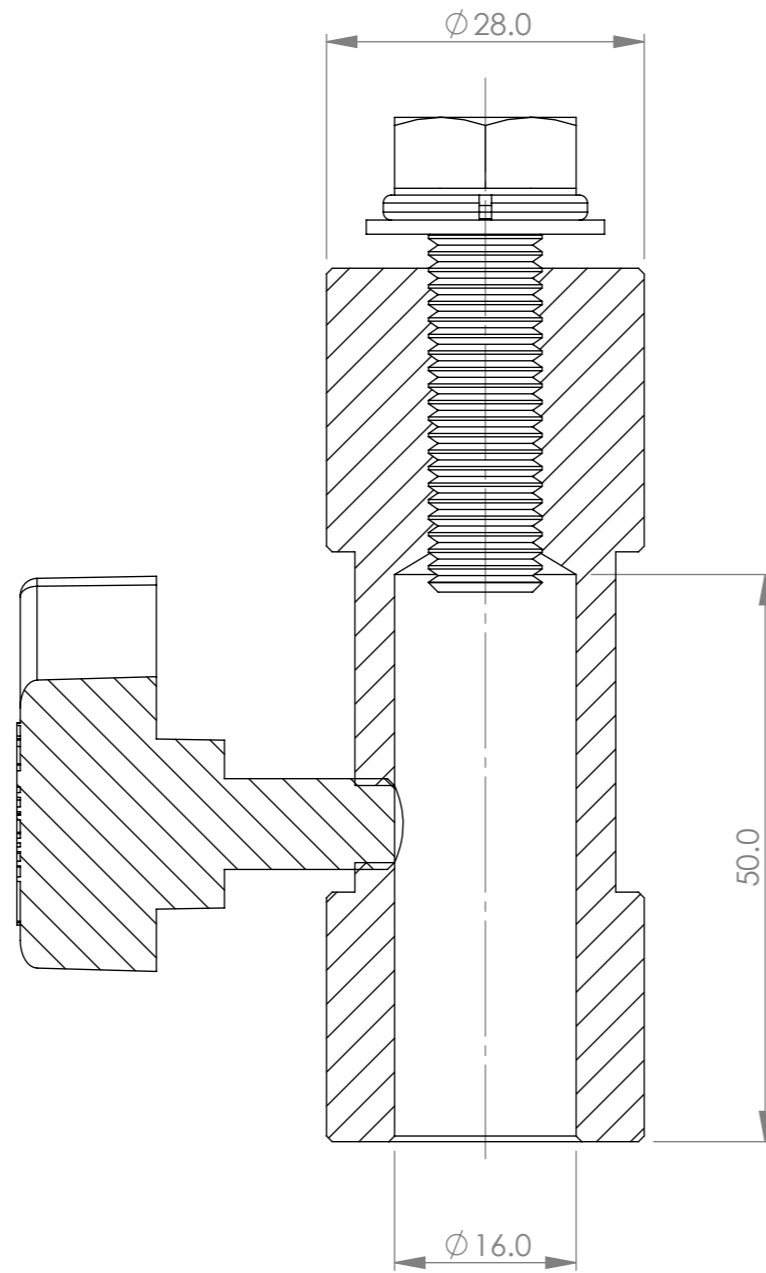
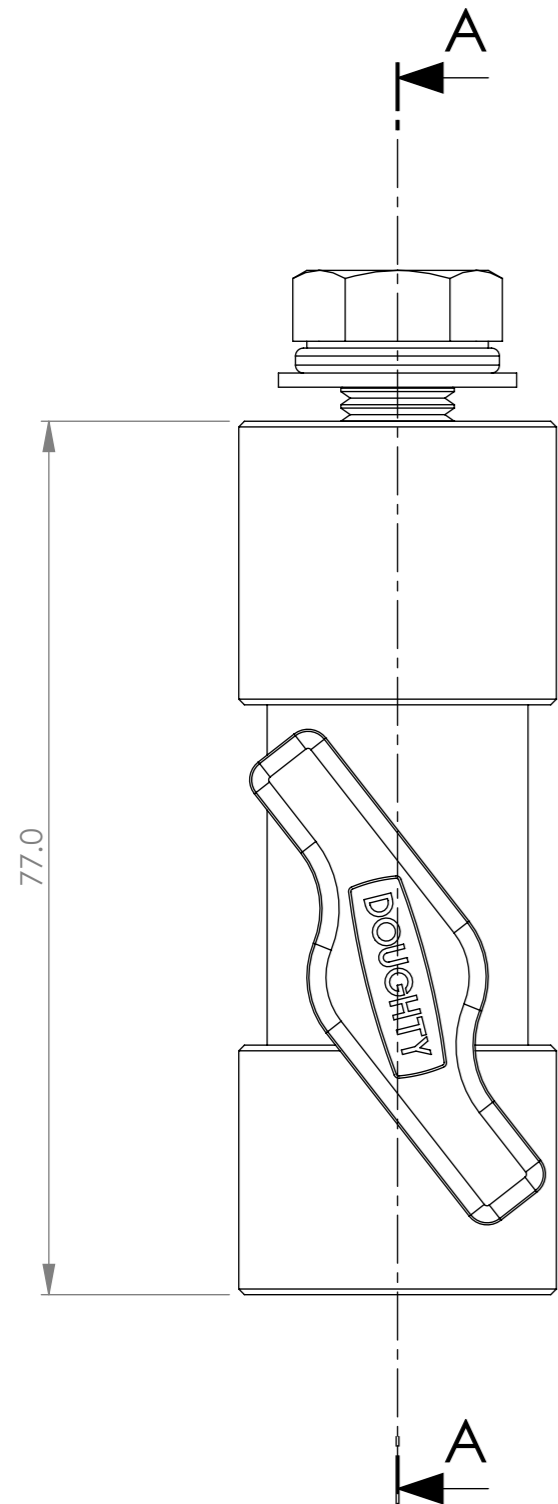

SECTION A-A

