

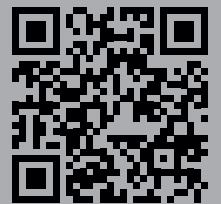

Data Connectors



Content	Page
Fiber Optic:	
opticalCON ADVANCED	90
opticalCON DUO - Cable Connector Assembly	92
opticalCON DUO - Chassis Connector	92
opticalCON QUAD - Cable Connector Assembly	93
opticalCON QUAD - Chassis Connector	93
opticalCON MTP® - Cable Connector Assembly.....	94
opticalCON MTP® - Chassis Connector	94
opticalCON Breakout Boxes & Coupler.....	95
opticalCON D-shape Z-panels	95
opticalCON powerMONITOR	96
opticalCON Accessories & opticamSWITCH	97
opticalCON LITE.....	98
opticalCON DUO LITE - Cable Connector Assembly	100
opticalCON QUAD LITE - Cable Connector Assembly	100
opticalCON MTP® LITE - Cable Connector Assembly	101
Network Interconnections:	
etherCON - CAT6A Cable Carrier	103
etherCON - CAT6A Receptacles	103
etherCON - CAT6A - Technical Data.....	104
etherCON - CAT6A - Ordering Information	104
etherCON - CAT5e A / B / D type Receptacle	105
etherCON - Receptacles.....	106
etherCON - Receptacle Shield & Lighted	107
etherCON - Feedthrough	107
etherCON - Cable Carrier	108
etherCON - Technical Data	109
etherCON - Ordering Information	110
etherCON - Accessories	111
etherCON - CAT6 Patch Cable.....	112
etherCON - CAT6 Receptacles	112
etherCON - CAT6 - Technical Data	113
etherCON - CAT6 - Ordering Information	113
Digital Interfaces (USB / IEEE / HDMI / D-SUB):	
USB Patch Cable	114
USB 2.0 Receptacle	115
USB 3.0 Receptacle	115
Technical Data USB Receptacle and Patch Cable	116
Ordering Information USB Receptacle and Patch Cable ...	116
HDMI Patch Cable	117
HDMI Receptacle	117
Firewire Receptacle	118
D-SUB Receptacle.....	118
HDMI, Firewire, D-SUB - Technical Data	119
HDMI, Firewire, D-SUB - Ordering Information	119
Accessories	120

Introduction

Neutrik's continuously growing range of data connectors copes with the increasing and versatile demand of digital connections in the professional audio, broadcast and entertainment industry.

Networking and computerized controls have to be equipped with reliable and rugged interconnection systems, since conventional data connectors can not meet the demanding requirements of live / rental or broadcast applications.

Neutrik early understood this trend and realized a range of ruggedized connection systems based on standard digital interconnection products like fiber optic and network interconnections as well as Digital Interfaces HDMI, USB, D-SUB and Firewire to suit the high demands of professional users in the entertainment industry.

NEUTRIK®, crystalCON®, etherCON®, maxCON®, miniCON®, nanoCON®, neutriCON®, opticalCON®, powerCON®, Profi®, rearTWIST®, silentPLUG®, speakON®, DIWA®, XIRIUM®, are registered trademarks of Neutrik AG.

Fiber Optic

A few years ago, fiber optic cables were used for specific applications only. With the transition to HD-signals and the upcoming 4K / 8K technology the need for fiber optics has increased significantly. Today, fiber optic cables are widely-used for various applications in the fields of professional broadcast, pro audio and touring/rental industries.

- Digital HD video transmissions > 15m (e.g. DVI, HDMI or KVM projection) using fiber optic media converters
- Increased bandwidth, especially for professional broadcast applications
- Efficient handling due to smaller and lighter cables
- Minimized cabling by embedding multiple data signals in single cables
- Future-proof installations designed to eliminate distance limitations, noise and EMI protection on audio or video (LED walls) applications

With the increased use of fiber optics for pro audio and broadcast new connections had to be developed. Conventional data-communication connectors (ST, SC, LC, etc.) are optimized for permanent, one-time connections and cannot cope with the harsh and demanding environment occurring in the entertainment business.

Neutrik solved the various problems associated with mobile fiber optic connectivity by launching the opticalCON series in 2005.

The simple and rugged design of opticalCON provides low fiber maintenance, high mating cycles and easy handling. Well known professional equipment manufacturers as well as key users in the pro broadcast and touring industry trust in the opticalCON system for years. It's Neutrik's goal to turn opticalCON into an industry standard comparable to the widely used etherCON series.

Design Criteria

Neutrik solved the various problems associated with mobile fiber optic connectivity with the launch of the opticalCON DUO fiber optic connection system in 2005.

opticalCON's reliable and simple concept, with ruggedness and low maintenance at its core, has gained wide acceptance in the pro audio and broadcast industries. Well-known professional equipment manufacturers as well as key users in broadcast and rental/ touring trust in opticalCON for years. It is Neutrik goal to turn opticalCON into an industry standard comparable to the widely used etherCON series.

opticalCON DUO is most typically used for equipment connections, including various audio, lighting, and video applications. Typical uses include audio and DMX networks (ring switch), video projection based on fiber optic DVI, HDMI, or KVM signal converters, mobile LED panels, and various broadcast applications.

Following on the success of opticalCON DUO, the newer **opticalCON QUAD** series doubles the fiber count to four per cable and is designed with point-to-point connections in mind. opticalCON QUAD has been successfully deployed in such applications as data routing for big and, especially, OB outdoor broadcast applications.

The **opticalCON MTP®** increases the numbers of fibers in one connector to 12 and is the ideal solution for multi-fiber point-to-point applications as often required for broadcast applications.

Alternatively SPLIT cables, assembled with opticalCON DUO or QUAD, support a connector standardization and offers advantages with regard to field assembly and repair costs.

With the brand new **opticalCON LITE**, a cost effective lightweight connector based on LC based ferules. Neutrik offers a high performance fiber connection system for permanent and temporary installations like server rooms, patch fields and indoor cabling.

Fiber optic systems

opticalCON ADVANCED

- MOBILE USE
- RUGGED
- LOW MAINTENANCE
- SIMPLE INTEGRATION

UHD 4K8K

Lockable, O-ring sealed
metal protection cap

Custom color coding

Protective rubber coating

Ratched lock bushing

Ergonomic anti-kink boot
for various cable O.D.s



opticalCON DUO

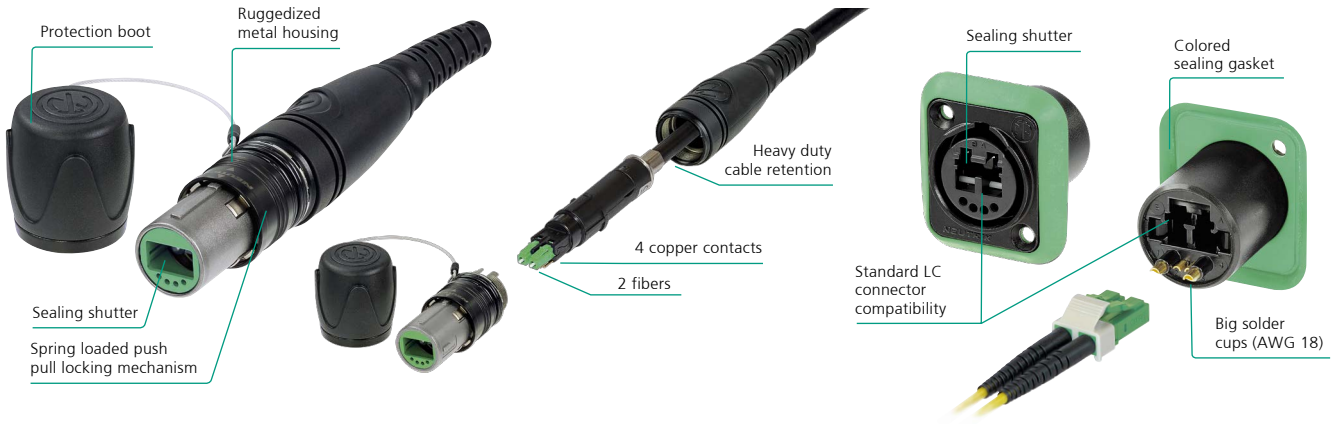

opticalCON QUAD

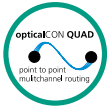

opticalCON MTP®





Rugged metal housing



Cable drum



Rubber coated protection cover



Rear LC connection



Chassis with transceiver adapter

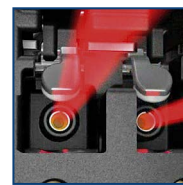

Sealing shutters

Cable Connector Assembly



NKO2S-A*

- Ruggedized and dirt-protected 2 channel fiber optic connection system
- Waterproof acc. to IP 65 in mated condition
- Color-coded cable connector comes pre-assembled with a choice of mobile field cables
- Accommodates standard optical LC-Duplex connectors
- Dust and dirt protection due to automatic sealing shutter with silicone gasket
- Reliable Push-Pull locking mechanism
- Easy to clean, no tools required
- Field repairable
- Hybrid assembly available

NKO2*

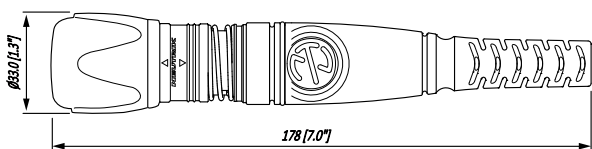

Chassis Connector



NO2-4FDW-A with SCDP-0

- Suggested OEM equipment connectors due to LC front compatibility
- Accommodates standard LC connectors on the rear for simple installation
- Automatic shutter with silicone gasket protects optical connection from dust and dirt
- Waterproof acc. to IP 65 ingress protection in mated condition
- Connection on the front side either with rugged opticalCON or standard LC connector
- Compatible with opticalCON ADVANCED, LITE and standard LC connector

NO2-4FDW-A

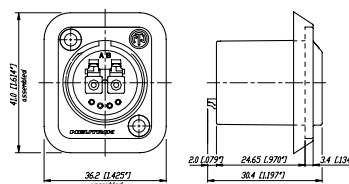



Colour Coding



Sealed and rugged housing



Sealing shutter



Sealed housing



Rear LC connection

Cable Connector Assembly



NKO4S-A*

- Ruggedized and dirt protected 4 channel fiber optic connection system
- Designed for POINT-TO-POINT multichannel routing
- Innovative shutter guarantees low maintenance
- Dust and water resistant according to IP 65 in mated condition
- Color-coded cable connector comes pre-assembled with a choice of mobile field cables
- Field repairable

Chassis Connector



NO4FDW-A with SCDP-0

- Rugged 4 channel POINT-TO-POINT multi-channel routing solution
- Laser protective metal shutter seals dust proof with two-component rubber gasket
- Waterproof acc. IP 65 in mated condition
- Accommodates standard LC connectors on the rear for cost effective and simple installations
- Compatible with opticalCON ADWANCED, and LITE connector

NKO4*

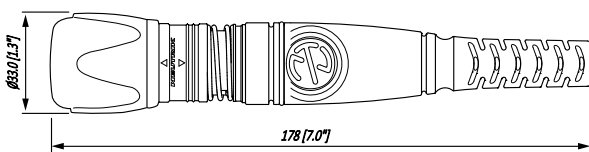

NO4FDW-A

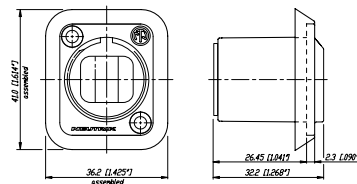

Find more details in the opticalCON Guide and on www.neutrik.com.



Rugged metal housing

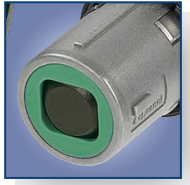

Spherical shutter



Rubber sealing gasket



Rear MTP® connection

Cable Connector Assembly



NK012S*

- Ruggedized and dirt-protected 12 channel fiber optic connection system
- For POINT-TO-POINT multichannel routing based on MTP® technology
- Cable connector features rugged all-metal housing and heavy-duty cable retention
- Innovative shutter guarantees low maintenance
- Dust and water resistant according to IP 65 in mated condition
- Enhanced maintenance
- Reliable Push-Pull locking mechanism

NK012*

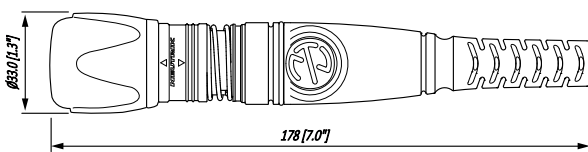

Chassis Connector



NO12FDW-A with SCDP-0

- Ruggedized and dirt-protected 12 channel fiber optic connection system
- For POINT-TO-POINT multichannel routing
- Laser protective metal shutter seals dust-proof with two-component rubber gasket
- Dust and water resistant according to IP 65 in mated condition
- Accommodates standard MTP® connectors on the rear for simple installation
- Rubber sealing gasket (black, blue, green to identify fiber mode)
- Compatible with opticalCON ADVANCED, and LITE connector

NO12FDW-A

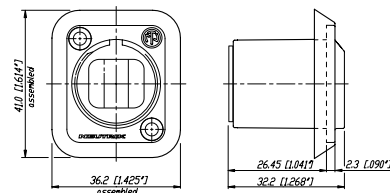



Color coding



DUO, QUAD & MTP® Couplers



Frame with opticalCON



Individual frame application

Breakout Boxes & Coupler



NO12SABB6D-A



NAO2S-H1W-A

- Breakout boxes are used to split multichannel connections like the opticalCON QUAD and MTP® to either dual or single channels
- Dust and waterproof according to IP 65 in mated condition
- Weather proof opticalCON DUO, QUAD and MTP® coupler (adapter) for cable extensions

NO12SABB6D-A

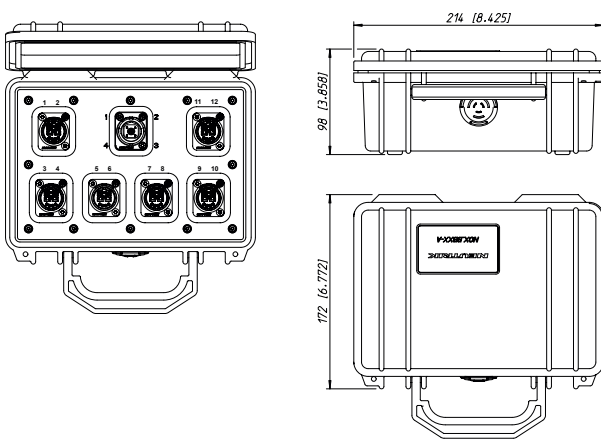

19" Z-Panel & Plates



NZPF1RU



NZPF3RU equipped with frame plates

- Space saving design, ideal for cramped rack applications such as OB truck I/O panels
- Frame plate can be loaded with opticalCON DUO or QUAD and E2000, ST or SC
- Frames can be equipped with frame plates (D-shape) or blind plates
- Best cable bend protection
- 1 RU or 3 RU frame

NZPF1RU

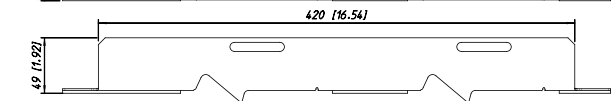
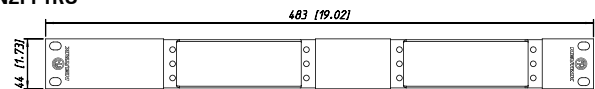

NZPF3RU

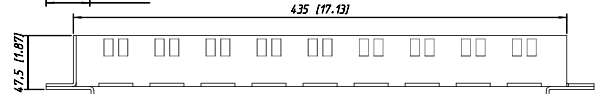
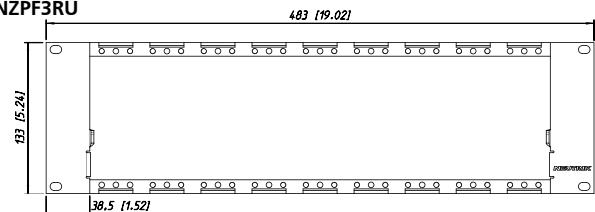

Find more details in the opticalCON Guide and on www.neutrik.com.



Breakout Box with powerMONITOR



3RU frame with up to 9 powerMONITORs



1RU rack mount



Robust rear connection

powerMONITOR



NO45-4F-2R-PM-A



The opticalCON powerMONITOR is a cost-saving, purpose-built measurement (monitoring) device for professional fiber optic broadcast, audio and video applications.

With simultaneous monitoring of attenuation for up to 4 transmission channels, powerMONITOR provides an immediate, "on air" view into fiber optic signal strength. Visual and audible alarms can be set individually for each fiber channel, based on each channel's power budget. powerMONITOR provides clear status information, delivers early warnings for potential problems, and assists with maintenance scheduling.

- On-air monitoring of fiber optic transmission quality
- Simultaneous power measurement (+0.0 / -0.1 dB measurement accuracy) of up to 4 channels
- Programmable threshold alarms
- Rack mount and mobile units
- Operates on rechargeable battery power or on mains power with fail-safe battery backup in case of unexpected mains power interruption
- Low loss (0.5 dB maximum split loss)
- Wavelength selectable: multimode 850 nm or 1'300 nm, single mode 1'310 nm, 1'550 nm or WDM (wave division multiplexing)
- External output for alarm signal

NO45-4F-2R-PM-A

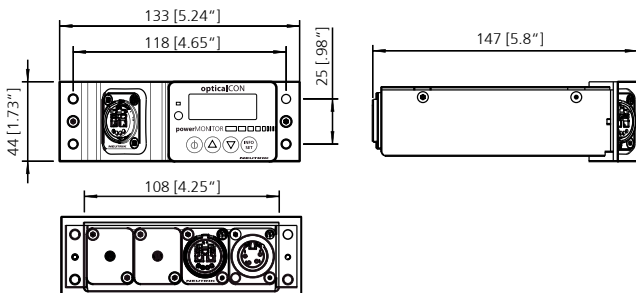



19" x 1 1/2 RU Rack unit



Ergonomic panel



Wieland rear connection



Coupler NAO4MW-A

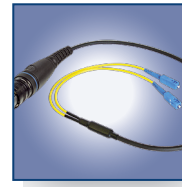

Breakout Cable



opticalCON Field assembly

Accessories & optiCamSWITCH



optiCamSWITCH



CAS-FOCD-ADV



CAS-FOMD



NAOBO

The optiCamSWITCH is the ultimate solution for fiber optic camera routing within broadcast studios. The device allows switching of unlimited camera positions between several studios and control rooms, eliminating the need for high-maintenance, risky matrix patch fields using SMPTE patch cables. The device works on trendsetting, silica-based PLC (planar lightwave circuits) equipped with TO (thermo optic) switches. The innovative design guarantees rugged and safe non-blocking fiber plus camera power switching without any moving parts. The LAN-based remote control software simplifies work, shows switching and camera status, and enables broadcast production automation.

- Thermo Optic PLC Switch
- 8 x 4 Non Blocking Structure
- Intelligent Power Working Circuit
- LAN Remote Control

- Rugged couplers to extend two opticalCONs
- Breakout cables
- NAOBO Kit – for flexible chassis mounting solution
- Assembly Tools:
 - Case for opticalCON field assembly
 - Fiber Optic Cleaning Devices (CAS-FOCD-ADV)
- Transceiver adapter connects opticalCON chassis and multi / singlemode transceivers
- Color coding
- Sealing covers

Find more details in the opticalCON Guide and on www.neutrik.com.

opticalCON LITE

- SMALL FORM FACTOR
- TACTICAL PATCH CABLE
- SAFE CONNECTION
- COST EFFECTIVE

UHD 4K8K

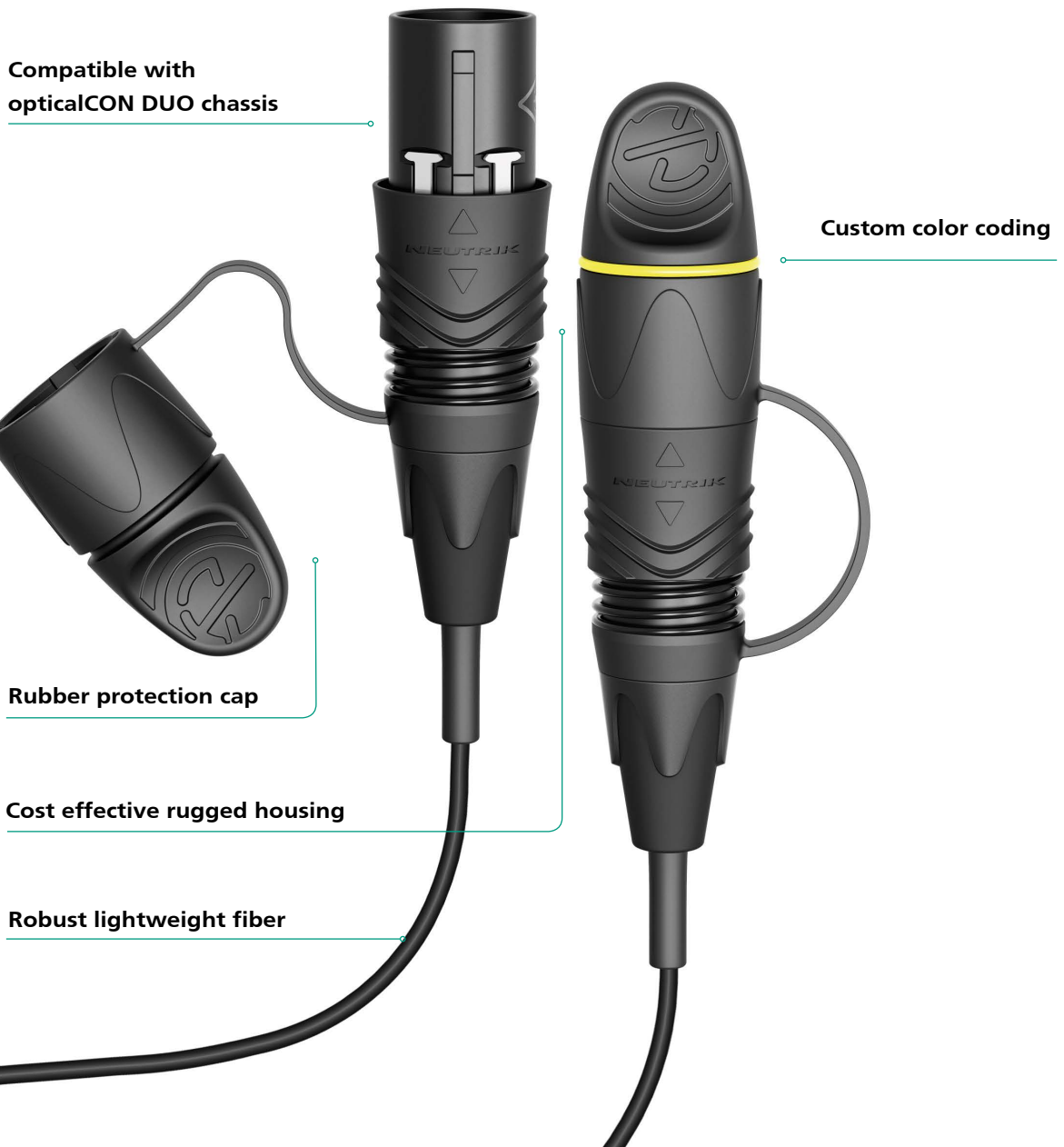

opticalCON DUO LITE

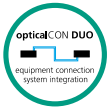

opticalCON QUAD LITE

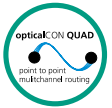

opticalCON MTP® LITE





Push-pull locking

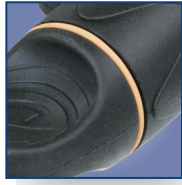

Custom color Coding



Color-coded cable connector



4 channel fiber optic

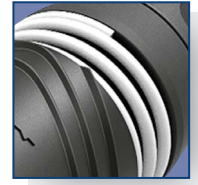

Color coded cable connector

opticalCON DUO LITE



NKO2M-L-0*

- 2 channel fiber optic connection system
- Cost optimized fiber connection for semi and permanent installations
- Waterproof acc. to IP65 safety standard in mated condition
- Space saving design
- Push-Pull locking mechanism for save connection
- Easy to clean, no special tools required
- Compatible with standard opticalCON DUO chassis NO2-4FDW-A*

opticalCON QUAD LITE



NKO4M-L-0*

- 4 channel fiber optic connection system
- Waterproof acc. to IP65 safety standard in mated condition
- Push-pull locking mechanism
- Recommended for POINT-TO-POINT connection
- Easy to clean, no special tools required
- Tactical patch cable
- Compatibel with standard opticalCON QUAD NO4FDW-A chassis

NKO2M-L-0*

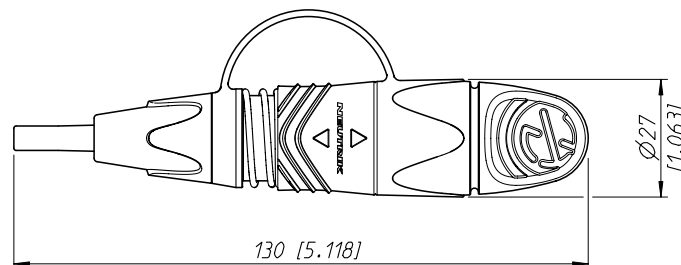



12 channel MTP®

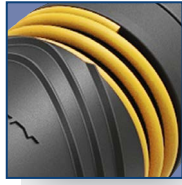

Color coded cable connector

opticalCON MTP® LITE



NKO12M-L-0-*

- 12 channel MTP® based fiber optic connection system
- Waterproof acc. to IP65 safety standard in mated condition
- Recommended for multi-signal transmission
- Push-pull locking mechanism
- Custom color coding
- Rugged plastic housing
- Rubber protection cap

Tactical Patch Cable

Conventional patch cables are sensitive in terms of undercutting the minimum bending radius and lateral pressure. Neutrik's tactical patch cables feature unique fiber design including a protection buffer which allows bendings with minimal radius and increased lateral pressure. Therefore the tactical patch cables are the right choice for permanent or semi-permanent applications.

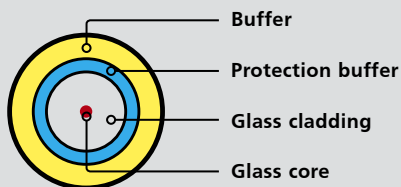

Find more details in the opticalCON Guide and on www.neutrik.com.

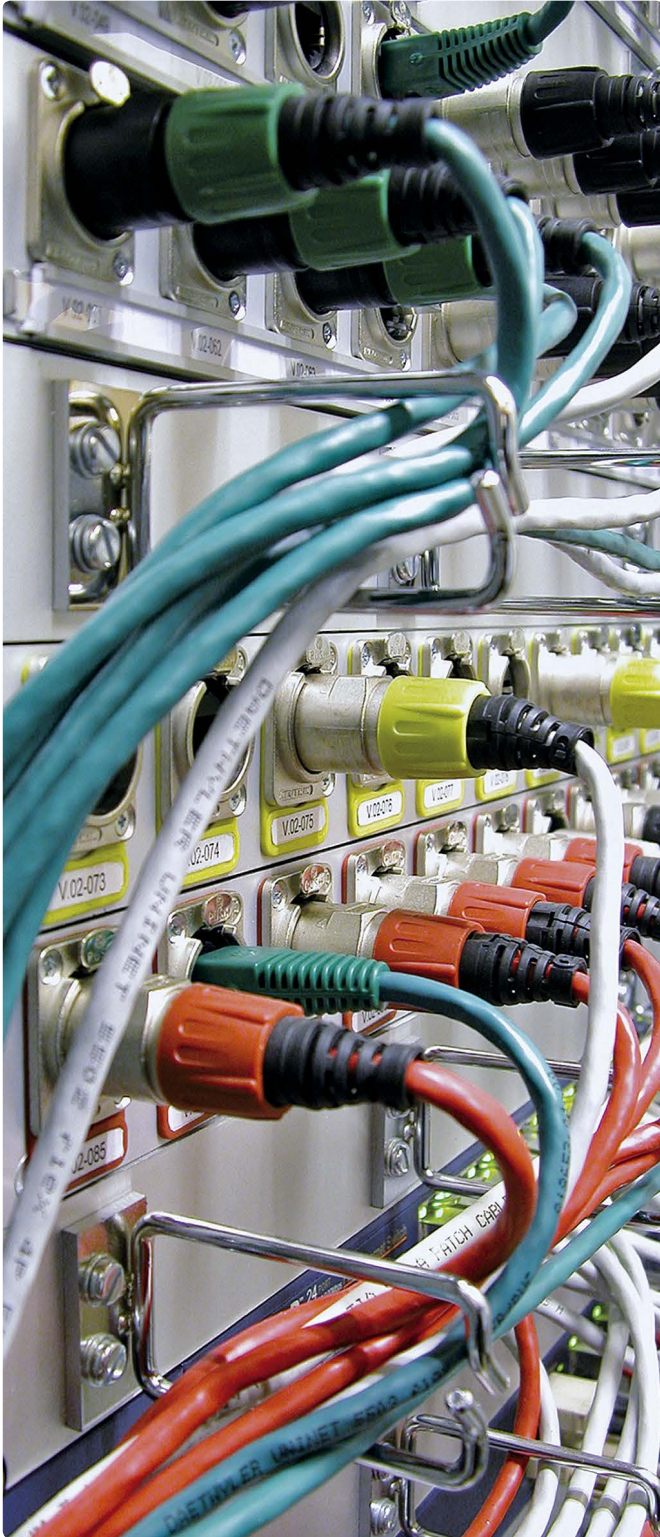

etherCON

Ruggedized RJ45 Data Connector

etherCON provides solutions for data transfer in harsh and demanding applications. These connectors are especially applicable for Ethernet networking in audio, commercial, entertainment, live stage production, DMX lighting, industrial and outdoor internet access environments.

The etherCON series offers tailor-made products to suit all state-of-the-art transmission classes like CAT6A, CAT6, CAT5e as well as class D according to TIA / EIA 568C.2 and ISO / EC 11801 respectively EN 50173-1 standard. The broadly based product range includes male cable carriers, assembled female receptacles, feedthrough jacks, cable couplers and shielded versions with or without illumination possibilities by LEDs. For pre-assembled RJ45 cables Neutrik offers a rugged diecast metal shell as a male cable carrier, which does not require the re-termination of the cable assembly.

Female chassis receptacles are based on the well known Neutrik "A & B" series as well the "D" series of XLR receptacles with either secure latching system or push pull locking (CAT6) – features not found on other RJ45 receptacles. Terminations available do include horizontal and vertical PCB mount or IDC. Ingress protection of IP 54 is achieved on the CAT 5 version by assembling the waterproof sealing kit SE8FD while CAT 6 versions are IP 65 rated as standard and at the new CAT6A range it is customers choice to use the IP 65 protected receptacles or the unprotected versions.



Rugged diecast shell



Feedthrough



IDC Version



IP 65 Protected

etherCON

etherCON CAT6A Series



NE8MX6



NE8FDX-P6



NE8FDX-Y6-W

- Ruggedized connector range with CAT6A component compliance according to ISO / IEC 11801 respectively EN50173-1 and CAT6A according to TIA / EIA 568-C.2
- D-size chassis connector for IDC self-termination or as feedthrough adapter
- IP 65 protected version available
- PoE+ compliant according to 802.3at Type2
- Downwards compatible with the existing etherCON CAT5 range

CAT6A / CAT5* compatibility:

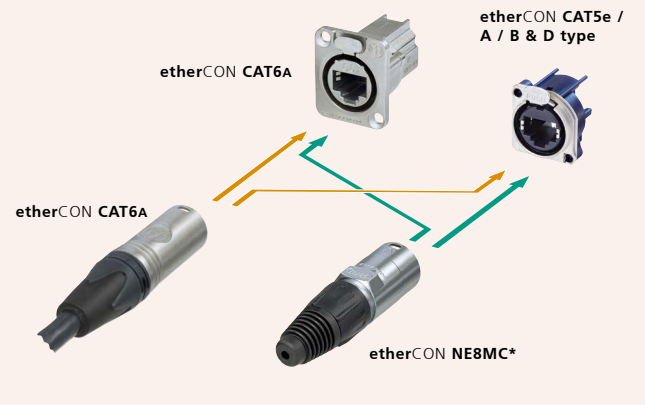

NE8MX6

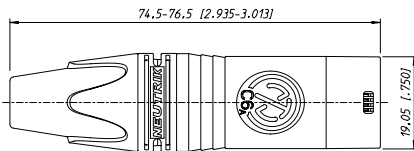

NE8FDX-Y6

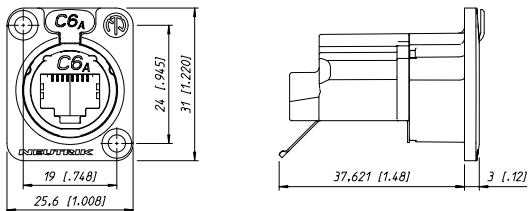

NE8FDX-P6-W

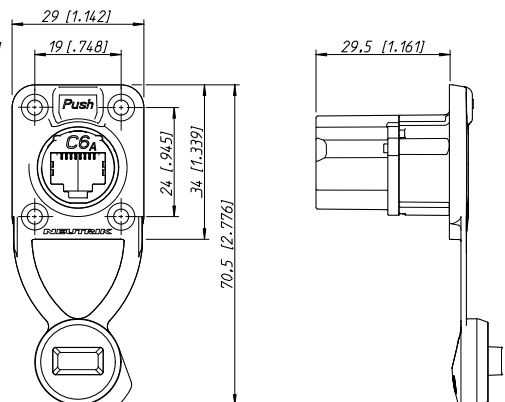

Technical Data

		Receptacle	Cable connector
Electrical			
Number of contacts	8	●	●
Rated current per contact	1.5 A	●	●
TIA / EIA rating	CAT6A	●	●
IEC / ISO / EN rating	CAT6A	●	●
Input to output resistance	< 200 mΩ	-	-
Insulation resistance	> 500 MΩ	●	●
Dielectric strength	1 kV dc	●	●
PoE + acc. IEEE 802.3at		●	●

Materials

Housing	Zinc diecast	●	●
Adapter	Polyamide PA 6	-	-
Strain relief clamp	POM	-	●
Contacts	Bronze CuSn	-	-
	Spring steel	●	●
Contact surface	Gold	●	●
Bushing	PU / PA	-	●

Mechanical

Retention method	Latch Lock	●	●		
Life time (mating cycles)	> 1'000	●	●		
Cable O.D. range	7.0 - 9.5 mm	●	●		
Wire size	solid	NE8FDX-Y6(-B)(-W):	AWG 26/1 - 22/1	NE8MX6(-B):	AWG 24/1 - 22/1
	stranded wire		AWG 26/7 - 22/7		AWG 24/7 - 22/7
Insulation diameter			> 0.85 - 1.6 mm		> 1.10 - 1.60 mm
Wire size	solid	-		NE8MX6(-B)-T	AWG 26/1 - 24/1
	stranded wire	-			AWG 27/7 - 24/7
Insulation diameter		-			> 0.85 - 1.10 mm

Environmental

Operating temperature / Storage temperature	-40 °C to +70 °C	●	●
Flammability	UL94V-0	●	●
Protection class	IP 65 in combination with "-W" receptacle	●	●

Ordering Information

Cable Connector		Receptacle	
NE8MX6	CAT6A, nickel plating, ≥ AWG 24	NE8FDX-P6	CAT6A shielded feedthrough, nickel plating
NE8MX6-B	CAT6A, black plating, ≥ AWG 24	NE8FDX-P6-B	CAT6A shielded feedthrough, black plating
NE8MX6-T	CAT6A, nickel plating, ≤ AWG 24	NE8FDX-Y6	CAT6A shielded IDC, nickel plating
NE8MX6-B-T	CAT6A, black plating, ≤ AWG 24	NE8FDX-Y6-B	CAT6A shielded IDC, black plating
		NE8FDX-P6-W	CAT6A shielded feedthrough, with integrated rubber sealing cap, IP 65
		NE8FDX-Y6-W	CAT6A shielded IDC, with integrated rubber sealing cap, IP 65

Accessories and Assembly Tools

HTXX-14	Handtool to tighten the NE8MX6* bushing	XXR*	Colored coding ring (see page 38)
HX-CAT6A	Parallel press tool for etherCON CAT6A Series	XXCR	Translucent coding ring (see page 38)



IDC Terminals



Horizontal PCB

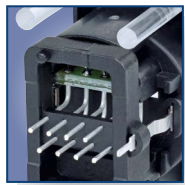

Vertical PCB with lightpipes



D shape metal shell



PCB Version

etherCON CAT5e A/B & D type Receptacle



NE8FAH-C5



NE8FBH-C5-LED



NE8FBV-C5-LED-S

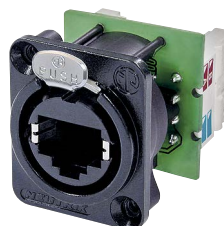

NE8FDV-Y110-B



NE8FDH-C5E

- Space saving A or B type receptacles - horizontal or vertical PCB design available
- Vertical PCB design at 24 mm distance to front panel - fits the widely accepted industry standard dimensions for XLRs, 1/4" jacks etc.
- PoE+ compliant according to 802.3at Type2
- CAT5e performance according to ISO /IEC 11801 and TIA /EIA 568-C.2
- Shielded or non-shielded versions available
- Two types of light pipes available to accommodate through hole LEDs or SMD-LEDs
- Accommodates rugged etherCON NE8MC* cable carriers or any standard RJ45 plug
- D type receptacles - horizontal PCB or punch terminal (Krone or 110) design available

NE8FBH-C5-LED

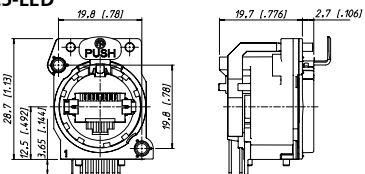

NE8FDV-Y110

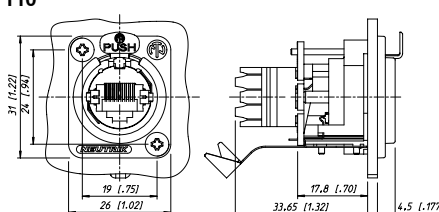

NE8FBV-C5-LED-S

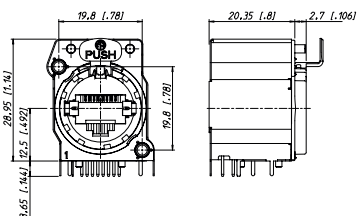

NE8FDH-C5E

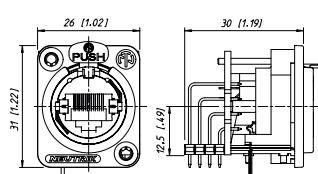

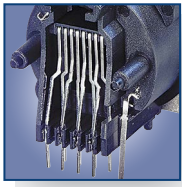

Horizontal PCB

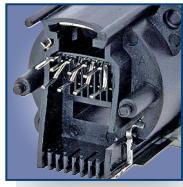

Vertical PCB



NE8FDV-SE – Vertical PCB receptacle combined with waterproof kit

etherCON – Receptacles



NE8FAV + ACRF-2



NE8FBH



NE8FDV



NE8FDV-SE

- "A / B" and "D" sized receptacles available in vertical and horizontal PCB or IDC terminations
- Accommodates NE8MC carriers or any standard RJ45 Plug
- D-versions with unified metal flange equal to "D" series-XLR, speakON, powerCON and BNC Bulkhead
- Receptacles comply with Class D (PCB versions) or CAT 5e (IDC versions and NE8FDH-C5E) according to TIA / EIA 568B and ISO / IEC 11801 standard
- Version with screw domes to fix connector onto PCB securely (NE8FAV-SD)

NE8FAV

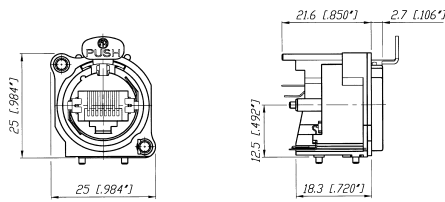

NE8FBH

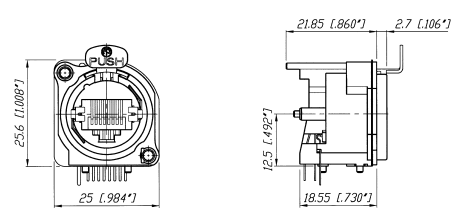

NE8FAV-SD

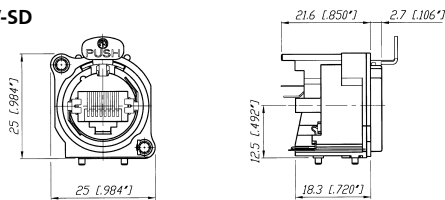

NE8FDV

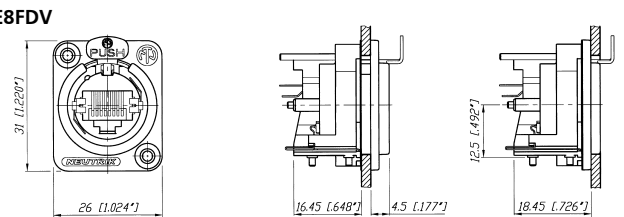



Completely closed housing



Light pipe

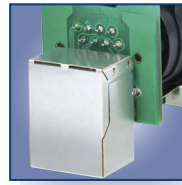

NE8FDP-R rear side



Locking latch



Rugged aluminium extrusion housing

Shielded & Lighted



NE8FBH-S



NE8FBH-LED



NE8FDP-R



NE8FF

Feedthrough

- Comprehensive shielding granted by completely closed metal housing
- Improves EMC performance of appliance even in unmated condition
- Light pipes illuminated by standard 3 mm LEDs – to be mounted on PCB by customer
- Receptacles comply with class D Link performance.

- Feedthrough as panel mount receptacle and as cable coupler
- NE8FDP feedthrough connector in D series housing for use in patchfields – rear side accommodates standard RJ45 plug.
- New: Right angle version available (NE8FDP-R).
- NE8FF coupler (adapter) for cable to cable mating – use with NE8MC carriers or any standard RJ45 plugs

NE8FBH-S

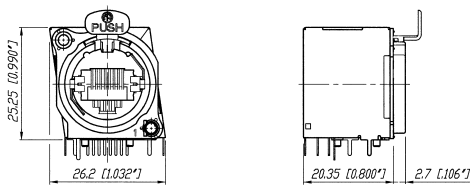

NE8FBH-LED

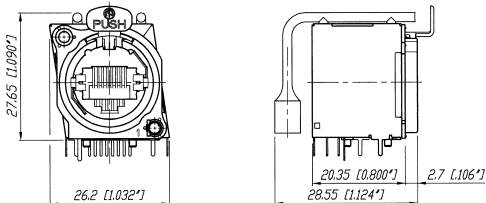

NE8FDP-R

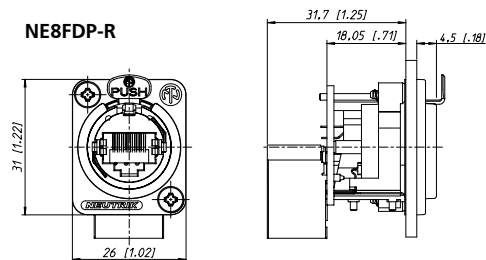

NE8FF

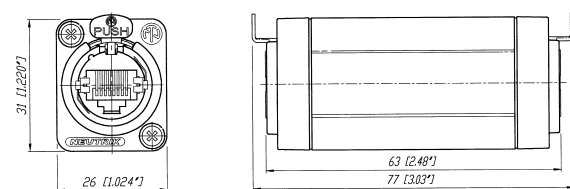



Rugged diecast shell



Colored coding
Bushing

etherCON – Cable Carriers



NE8MC-1



NE8MC-B

- The RJ45 system for harsh and demanding environment
- Cable connector carrier accepts the most common RJ45 plugs
- Cable connector carrier has rugged diecast shell and unique chuck type strain relief
- NE8MC-1 version with weatherproof Chromium plating and O-ring gasket
- Protects Ethernet connections in a variety of commercial type applications and is designed to prevent breakage of the fragile components of standard RJ45 connectors
- Cable connector carrier does not include RJ45 plug

NE8MC

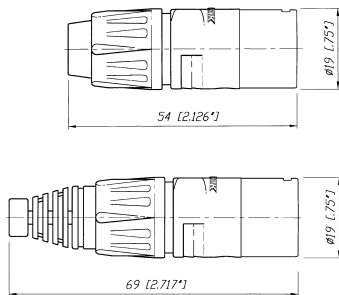

NE8MC-1

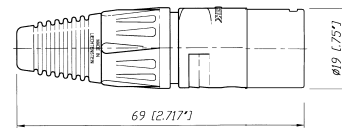

Specification		NE8MC* Cable Con.	NE8FA/B* (A + B Series)	NE8FD* (D Series)
Electrical				
Number of contacts	8	- ¹⁾	●	●
Rated current per contact	< 1.5 A	- ¹⁾	●	●
Rated voltage	< 50 V ac	- ¹⁾	●	●
Contact resistance	< 10 mΩ	- ¹⁾	●	●
Insulation resistance	> 500 MΩ	- ¹⁾	●	●
Dielectric strength	> 1'000 V ac rms	- ¹⁾	●	●
Frequency bandwidth	1 - 100 MHz	- ¹⁾	●	●
Transmission class acc. TIA / EIA 568B or IEC 11801	- CAT 5e	- ¹⁾	NE8*-C5* / NE8FA*-Y*	NE8FD*-C5e / NE8FD*-Y*
	Class D	- ¹⁾	●	●
PoE + acc. IEEE 802.3at		- ¹⁾	●	●
Mechanical				
Retention method	latch lock	●	●	●
Life time (mating cycles)	> 1'000 mating cycles	●	●	●
	> 200 mating cycles	-	-	SE8FD
Insertion / withdrawal force	≤ 20 N	●	●	●
Cable O.D. range	3.5 - 8 mm	●	-	-
Wire size	AWG 26 – 20	- ¹⁾	NE8*-Y*	NE8*-Y*
Panel thickness	max. 3 mm / 0.12"	-	●	4 mm / 0.16"
Material				
Housing	PBT D202G30	-	●	●
	Zinc diecast (ZnAlCu1, gal Ni / bl Cr / Chromium)	●	-	-
B / D-flange	Zinc diecast (ZnAlCu1, gal Ni / bl Cr)	-	●	●
Strain relief clamp	POM	●	-	-
Contacts	CuZn35Pb2, Tin plated	-	NE8*-Y*	NE8*-Y*
	Bronze (CuSn8)	- ¹⁾	●	●
	Spring steel	NE8*C5*	●	●
Contact surface	Au (gal 0.2 μm over Ni plating)	- ¹⁾	●	●
Locking Element	Ck 67 steel, treated	-	●	●
Bushing	Polyamide (PA 6 15% GR)	●	-	-
Boot	Polyamide (PA 6)	●	-	-
Sealing gasket	EPDM	-	-	SE8FD
Environment				
Operating Temperature	-30 °C to +80 °C	●	●	●
	-20 °C to +60 °C	-	-	SE8FD
Protection class	IP 54	-	-	SE8FD
Flammability	UL94V-0	UL94 HB	●	●
Solderability complies with	IEC 68-2-20	-	PCB Version	PCB Version
Mating screw		-	A screw	E screw
Color coding		BSE-* / BSX-*	ACRF-*	DSS-*
Footnote				
¹⁾ : Specs depend on type of RJ45 plugs used				

Ordering Information

	Shape				Termination					Remarks
	A	B	D	H	V	IDC	IDC 110	LED	S	
CAT 5e Receptacle										
NE8FAH-C5	•			•						
NE8FAV-C5	•					•				
NE8FAV-YK*	•						•			
NE8FAV-Y110*	•							•		
NE8FBH-C5		•		•						
NE8FBH-C5-S		•		•					•	
NE8FBH-C5-LED		•		•				•		through hole LED
NE8FBH-C5-LED1		•		•				•		SMD LED
NE8FBH-C5-LED-S		•		•				•	•	through hole LED
NE8FBH-C5-LED1-S		•		•				•	•	SMD LED
NE8FBV-C5		•				•				
NE8FBV-C5-S		•				•			•	
NE8FBV-C5-LED		•				•		•		through hole LED
NE8FBV-C5-LED1		•				•		•		SMD LED
NE8FBV-C5-LED-S		•				•		•	•	through hole LED
NE8FBV-C5-LED1-S		•				•		•	•	SMD LED
NE8FDH-C5e			•	•						
NE8FDH-C5e-SE			•	•						with sealing kit SE8FD
NE8FDV-YK*			•				•			
NE8FDV-Y110*			•					•		
NE8FDP*; NE8DFP-B			•							feedthrough; black plating
NE8FDP-SE			•							with sealing kit SE8FD
NE8FDP-R*			•							right angle port, feedthrough
NE8FDP-R-B*			•							right angle port, feedt., black plating
NE8FF			•							coupler, black plating

CLASS D Receptacle

NE8FAH	•			•						
NE8FAV	•					•				
NE8FAV-SD*	•					•				Screw dome
NE8FBH		•		•						
NE8FBV		•				•				
NE8FDV			•			•				
NE8FDV-SE			•			•				with sealing kit SE8FD

Cable Carriers

NE8MC	Cable housing with chuck and bushing (two antikink boots, one up to 5 mm and one up to 8 mm cable O.D.) (standard bushing in black, 9 different coding colours on request)											
NE8MC-B	Black chromium housing with chuck and bushing (two antikink boots, one for 5 mm and one for 8 mm cable O.D.) (standard bushing in black, 9 different coding colours on request)											
NE8MC-1	Cable housing with chuck and X-series bushing, Collinox plating and O-ring gasket (perfect for waterproof applications, standard bushing in black, 9 different coding colours on request)											
NE8MC-B-1	Black chromium housing with chuck and X-series bushing (standard bushing in black, 9 different coding colours on request)											
IMPORTANT:	Cable connectors do not include RJ45 plug. RJ45 cable assembly must be provided by end-user!											
INFORMATION:	A	A-shape receptacle (all plastic)							IDC	IDC terminals		
	B	B-shape receptacle (Nickel ring)							IDC 110 ..	IDC 110 punch down terminals		
	D	D-shape receptacle							LED	Light pipe		
	H	Horizontal PCB mount							S	shielded metal housing		
	V	Vertical PCB mount							*	Including 2 mounting screws		

Accessories



A screw



E screw



E screw Nickel



ACRF-*



DSS-*



BSE-*



BSX-*



SCDP-*



SCDX



SCCD-W

A-Screw	Mounting screw for A / B -shape (black self-tapping PLASTITE® screw 2.9 x 8, panhead)
E-Screw	Mounting screw for D-shape (black self-tapping PLASTITE® screw 2.9 x 12, countersunk)
E-Screw-Ni	Mounting screw for D-shape (Nickel self-tapping PLASTITE® screw 2.9 x 12, countersunk)
ACRF-*	Colored coding rings for A-shape receptacles (Box of 100 pcs.)
BSE-*	Colored boot for cable connector carrier (Box of 100 pcs.)
BSX-*	Colored bushing for NE8MC-1 and NE8MC-B-1 cable connectors
DSS-*	Lettering plate for D series, colored plastic
NZP1RU	Panel1RU D-shape housing
SCDP-*	D-Size sealing gaskets, color coding (*: 0- black, 2- red, 4- yellow, 5- green, 6- blue, 9- white)
SCDX	Hinged cover seals D-size chassis connectors, IP 42 rated
SCCD-W	Spring-loaded cover to seals for D-size chassis connectors, IP 65 rated

*: 0 - Black, 1 - Brown, 2 - Red, 3 - Orange, 4 - Yellow, 5 - Green, 6 - Blue, 7 - Violet, 8 - Grey, 9 - White



Waterproof kit for etherCON D-Series

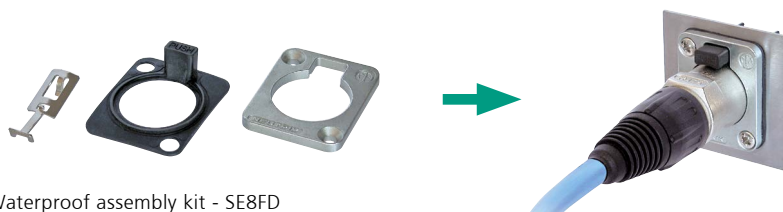

Waterproof assembly kit - SE8FD

SE8FD	Waterproof kit, IP 54, consists of push, gasket, frontplate Suitable for all NE8FD*, perfect in combination with NE8MC-1 (with Chromium plating and sealing gasket)
-------	---



Push Pull locking

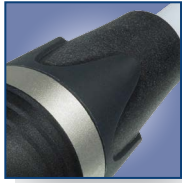

IP65 in mated condition



D-shape metal shell

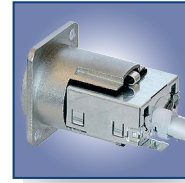

Closed shielding

CAT6 Patch Cable

CAT6 Receptacles



NKE65-*

NE8MC6-MO



NE8FDY-C6



NE8FDY-C6-B

- CAT6 compliant – according to ISO / IEC 11801, TIA / EIA 568C.2, EN50173-1
- Dust and water resistant according IP 65 in mated condition
- Push Pull mating design provides secure locking system
- Shielded system – high noise immunity and EMI protection
- IDC contacts for tool-free assembly offer gas-tight termination
- Ready made patch cables or cable connector for self termination with rugged diecast cable carrier and unique chuck-type strain relief

NKE65-*

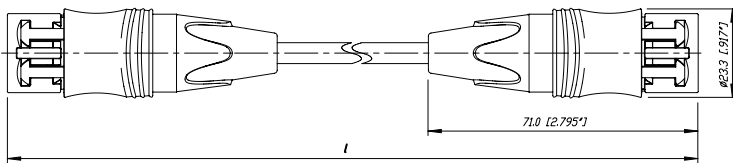

NE8FDY-C6

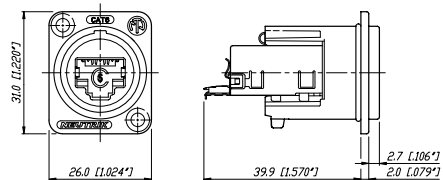

NE8MC6-MO

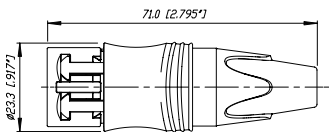

Technical Data

		Receptacle	Patch Cable
Electrical			
Number of contacts	8	●	●
Rated current per contact	1.5 A	●	●
TIA / EIA rating	CAT6	●	●
IEC / ISO / EN rating	CAT6A	-	-
Input to output resistance	< 200 mΩ	●	●
Insulation resistance	> 500 MΩ	●	●
Dielectric strength	1 kV dc	●	●
PoE + acc. IEEE 802.3at		-	-

Materials

Housing	Zinc diecast	●	●
Adapter	Polyamide PA 6	●	●
Strain relief clamp	POM	-	●
Contacts	Bronze CuSn	●	●
	Spring steel	-	-
Contact surface	Gold	●	●
Bushing	PU / PA	-	●

Mechanical

Retention method	Push-Pull	●	-
Life time (mating cycles)	> 1'000	●	●
Cable O.D. range	5.5 - 6.5 mm	●	●
Wire size (solid)	0.205 - 0.324 mm ² (AWG 24 - AWG 22)	●	●
Stranded wire	0.141 - 0.355 mm ² (AWG 26 / 7 - 22 / 7)	●	●

Environmental

Operating temperature	-10 °C to +60 °C	●	●
Storage temperature	-40 °C to +70 °C	●	●
Flammability	UL94HB	●	●
Protection class	IP 65	●	●

Ordering Information CAT6

Cable Connector

NE8MC6-MO RJ45 cable plug with carrier offering a robust metal shell with Push-Pull locking system

Patch Cable

NKE6S-* Standard lengths: 0.5, 1, 2, 3, 5, 10, 30 m

NKE6S*-WOC Equipped on one side with metal shell, standard lengths: 1, 2, 3, 5, 10, 30 m
Custom length in meter steps on request

Receptacle

NE8FDY-C6 CAT6 with Nickel D-shell

NE8FDY-C6-B CAT6 with Black Chrome D-shell

Accessories

see page 111 / 116 / 120



Push Pull locking



USB type B

U S B P a t c h C a b l e



NKUSB-*

- USB 2.0 compliant – data rate up to 480 MBit/s
- Dust and water resistant sealing in combination with NAUSB-W*
- Push Pull mating design provides secure locking system if mated with NAUSB-W*
- Shielded connection – high noise immunity and EMI protection
- Ready made patch cables (1 m, 3 m and 5 m) with removable rugged diecast cable carrier
- Mates with conventional USB receptacles if cable carrier is removed

NKUSB

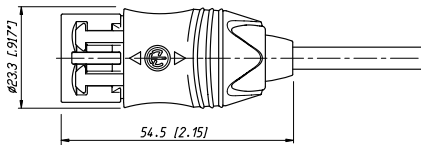



D-shape metal housing

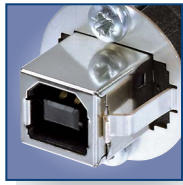

USB type B

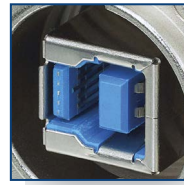

USB 3.0 Type B



Rugged housing

USB 2.0 Receptacle



NAUSB-W



NAUSB-W-B

- USB 2.0 gender changer type A-B (B-A)
- Ideal for audio networking and integration of computerbased equipment into audio systems
- Lockable connection and water protection if mated with Neutrik USB cable NKUSB-*
- Optional screen to chassis grounding
- Reversible insert offering type A or B on front or rear end
- Universally accepted standard D-shape housing

USB 3.0 Receptacle



NAUSB3



NAUSB3-B

- Rugged USB 3.0 feedthrough adapter
- Standardized D-shape housing
- Reversible insert offering type A or B on front or rear end
- Optional screen to chassis grounding
- Nickel and black chrome plating available

NAUSB-W

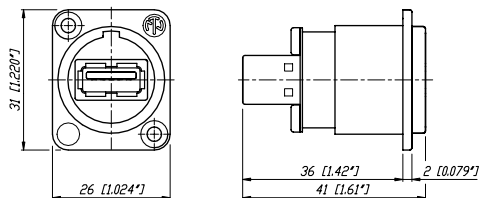

NAUSB3

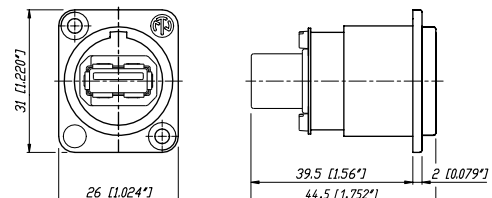

Technical Data

Mechanical and Electrical

Conform with USB 2.0 Standard

Receptacle

Patch Cable

•

•

Material

Shell Zinc diecast (ZnAl4Cu1)

•

•

Shell plating Nickel or black Chrome

•

Nickel

Insert

PBTP 15% GR

PVC

Contacts Brass (CuZn39Pb3)

•

•

Contact finish Gold

•

•

Environmental

Operating temperature -25 °C to +85 °C

•

•

Flammability UL94 V-0

•

•

Protection class IP 65

•

•

Ordering Information

Chassis

NAUSB-W USB 2.0: USB A – USB B Adapter (reversible), sealing ring, optional grounding, nickel housing

NAUSB-W-B USB 2.0: USB A – USB B Adapter (reversible), sealing ring, optional grounding, black housing

NAUSB3 USB 3.0: USB A – USB B Adapter (reversible), sealing ring, optional grounding, nickel housing

NAUSB3-B USB 3.0: USB A – USB B Adapter (reversible), sealing ring, optional grounding, black housing

Patch Cable

NKUSB-* USB 2.0 cable with overmolded flex relief and metal cable carrier, standard lengths: 1, 3, 5 m

Accessories



DSS-*



SCM



SCDX



SCCD-W



SCD-W



SCDP-*

DSS-** Lettering plate for D series, colored plastic

SCM Plastic sealing cover to protect the Firewire connectors against dust and moisture.

SCDP-* D-Size sealing gaskets, color coding

(*: 0- black, 2- red, 4- yellow, 5- green, 6- blue, 9- white)

SCDX Hinged cover seals D-size chassis connectors, IP 42 rated

SCCD-W Spring-loaded cover seals for D-size chassis connectors, IP 65 rated

SCD-W D-Size sealing cap, IP 65 rated

NZP1RU-8 Panel1RU housing with 8 D-shape cutouts

NZP1RU-12 Panel1RU housing with 12 D-shape cutouts

** : 0 - Black, 1 - Brown, 2 - Red, 3 - Orange, 4 - Yellow, 5 - Green, 6 - Blue, 7 - Violet, 8 - Grey, 9 - White





Push Pull locking

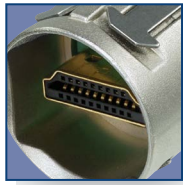

HDMI 1.4



D-shape metal housing



HDMI 1.4 receptacle



HDMI Patch Cable



NKHDMI-*

- HDMI 1.4 – data rate up to 10.2 GBit/s
- Push Pull mating design provides secure locking system if mated with NAHDMI-W*
- Shielded connection – high noise immunity and EMI protection
- Ready made patch cables (0.6 m, 1 m, 3 m, 5 m and 10 m) with removeable rugged diecast cable carrier
- Mates with conventional HDMI receptacles if cable carrier is removed
- Dust and water resistant sealing in combination with NAHDMI-W*

NKHDMI-*

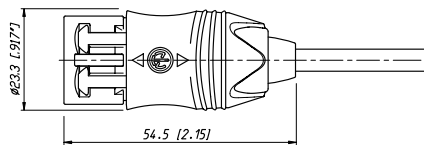

HDMI Receptacles



NAHDMI-W



- Audio / Video interface to transmit any digital TV and PC Video format including high-definition video (HDTV).
- HDMI 1.4 feedthrough adapter with 19 pole HDMI receptacle at both ends
- Optional screen to chassis grounding
- Universally accepted standard D-shape housing

NAHDMI-W

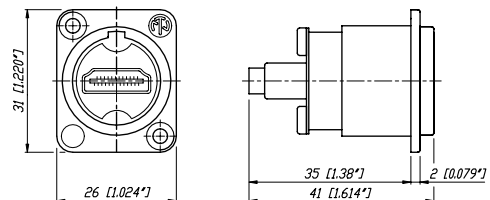

Firewire Adapter



D-shape metal housing



IEE 1394 receptacle



D-SUB data connector



D-shape metal housing



9 pole or 15 pole available

Firewire Receptacle



NA1394-6-W-B



NA1394-6-W

- Ideal for audio networking and integration of digital equipment into audio systems
- Firewire feedthrough adapter with 6 pole IEEE 1394 receptacle at both ends
- Optional screen to chassis grounding
- Universally accepted standard D-shape housing

D-SUB Feedthrough

NEW



NADB9MF-B



NADB15FF

- D-SUB feedthrough adapter
- Optimized ground connection
- Standardized D-shape housing
- 9 pole and 15 pole versions available
- "Male – Female" and "Female – Female" versions available
- Nickel and black chrome plating available

NA1394-6-W

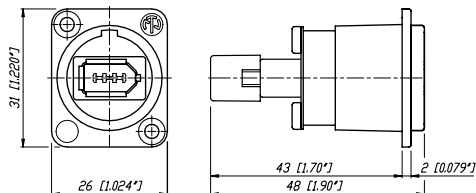

NADB9MF

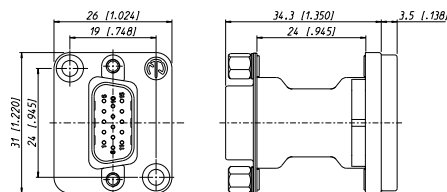

Technical Data

Mechanical and Electrical	HDMI Receptacle	HDMI Patch Cable	Firewire	D-SUB
Conform with Standards	HDMI 1.4	HDMI 1.4	IEEE	-

Material

Shell	Zinc diecast (ZnAl4Cu1)	●	●	●	●
Shellplating	Nickel or black Chrome	●	●	●	●
Insert		ABS	Nickel	PBTP 15% GR	Steel, tin plated
		-	PVC	-	PBT
Contacts	Brass (CuZn39Pb3)	●	●	●	●
Contact finish	Gold	●	●	●	●

Environmental

Operating temperature	-25 °C to +85 °C	●	●	●	●
Flammability	UL94 V-0	●	●	●	●
Protection class	IP 65	●	●	-	-

Ordering Information Firewire

NA1394-6-W	6 pole Firewire Adapter (IEEE 1394), sealing ring, optional grounding, nickel housing
NA1394-6-W-B	6 pole Firewire Adapter (IEEE 1394), sealing ring, optional grounding, black housing

Ordering Information HDMI

Chassis

NAHDMI-W	HDMI – HDMI Adapter, sealing ring, optional grounding, nickel housing
NAHDMI-W-B	HDMI – HDMI Adapter, sealing ring, optional grounding, black housing

Patch Cable

NKHDMI-*	HDMI 1.4 cable with overmolded flex relief and metal cable carrier, standard lengths: 0.6, 1, 3, 5, 10 m
----------	--

Ordering Information D-SUB

NADB9MF	9 pole D-SUB feedthrough male-female, D-shape nickel housing
NADB9MF-B	9 pole D-SUB feedthrough male-female, D-shape black chrome housing
NADB9FF	9 pole D-SUB feedthrough female-female, D-shape nickel housing
NADB9FF-B	9 pole D-SUB feedthrough female-female, D-shape black chrome housing
NADB15MF	15 pole D-SUB feedthrough male-female, D-shape nickel housing
NADB15MF-B	15 pole D-SUB feedthrough male-female, D-shape black chrome housing
NADB15FF	15 pole D-SUB feedthrough female-female, D-shape nickel housing
NADB15FF-B	15 pole D-SUB feedthrough female-female, D-shape black chrome housing

Accessories



DSS-*



SCM



SCDX



SCCD-W



SCD-W



SCDP-*

DSS-**	Lettering plate for D series, colored plastic
SCM	Plastic sealing cover to protect the Firewire connectors against dust and moisture.
SCDP-*	D-Size sealing gaskets, color coding (*: 0- black, 2- red, 4- yellow, 5- green, 6- blue, 9- white)
SCDX	Hinged cover seals D-size chassis connectors, IP 42 rated
SCCD-W	Spring-loaded cover seals for D-size chassis connectors, IP 65 rated
SCD-W	D-Size sealing cap, IP 65 rated (not suitable for NADB*)
NZP1RU-8	Panel1RU housing with 8 D-shape cutouts
NZP1RU-12	Panel1RU housing with 12 D-shape cutouts

**: 0 - Black, 1- Brown, 2 - Red, 3 - Orange, 4 - Yellow, 5 - Green, 6 - Blue, 7 - Violet, 8 - Grey, 9 - White

